



silhouettestudio®

V4

Table of Contents

Software Usage Agreement	1	5.2 Manipulating Text	34	10 - Print & Cut	81
Registered Trademarks	2	5.3 Text to Path	37	10.1 Registration Marks	81
Disclaimer	2	6 - Manipulating Images	38	10.2 Cutting Printed Images	82
About this Manual	2	6.1 Basics	38	11 - PixScan™	84
1 - General Information	3	6.2 Grouping/Ungrouping	41	11.1 Import from Scanner	84
1.1 System Requirements	3	6.3 Compound Paths	43	11.2 Import from Camera	85
1.2 Features Overview	4	6.4 Moving Images	45	11.3 Using PixScan™ images	87
1.3 Software File Formats	5	6.5 Rotating	46	12 - Curio Features	88
1.4 Available Digital Content	6	6.6 Sizing	47	12.1 Embossing	88
2 - Installing Silhouette Studio®	7	6.7 Mirroring	50	12.2 Stippling	92
2.1 Download	7	6.8 Arranging	51	12.3 Multiple tool use	95
3 - Basic Software Overview	8	6.9 Aligning	53	13 - Designer Edition Plus Features	96
3.1 Opening the Software	8	6.10 Replicating	55	13.1 Appliqué Embroidery	96
3.2 Software Sections	9	6.11 Nesting (Designer Edition only)	57	13.2 Advanced Rhinestones	98
3.3 Cutting/Drawing Area	11	6.12 Modify	58	14 - Business Edition Features	102
3.4 Opening Documents	12	6.13 Offset Options	61	14.1 Multi-Cutter Support	102
3.5 Document Tabs	13	6.14 Tracing Options	62	14.2 Ai/EPS/CDR file compatibility	103
3.6 Document Sizes	14	Trace	62	14.3 Design View vs. Media Layout View	103
3.7 Cutting Orientation	15	Trace Outer Edge	62	14.4 Tiling Feature	104
3.8 Viewing and Zooming	17	Trace and Detach	62	14.5 Automatic Nesting Preview	106
3.9 Preferences	18	7 - Library and Design Store	63	14.6 Matrix Copy Feature	108
4 - Drawing/Editing Images	21	7.1 Library	64	14.7 Automated Weed Line Feature	109
4.1 Basic Drawing Tools	21	7.2 Silhouette Design Store	66	15 - Troubleshooting	110
4.2 Editing Images	23	8 - Saving	73	15.1 Common Troubleshooting Tips	110
4.3 Line Tools	27	9 - Cutting/Sketching	74	15.2 Calibration	113
4.4 Fill Tools	29	9.1 Send	74	15.3 Further Support Contact Information	115
5 - Text	33	9.2 Performing a Test Cut	79	Silhouette Studio® Shortcuts	116
5.1 Creating Text	33	9.3 Cutting / Sketching	80		

Software Usage Agreement

Silhouette America Corporation ("Silhouette America") hereby grants the purchaser and authorized User (the "User") the right to use the software (the "Software") in accordance with the terms and conditions specified. By its purchase and/or use of the Software, the User hereby accepts and agrees to abide by the terms and conditions set forth herein.

1. Copyrights

All copyrights relating to the Software and accompanying printed materials such as manuals shall be retained by the individuals or organizations indicated in the Software or printed material.

2. License

The User may use the Software on one computer at a time.

3. Copying and modification

- (1) The User may copy the Software for backup purposes.
- (2) The User may not modify, combine, amend, or otherwise adapt the Software by any means, including disassembly and decompiling.

4. Third-party use

The User may not transfer, assign, or otherwise dispose of the rights relating to the Software or its use to third parties.

5. Warranty

- (1) Should the Software not operate correctly due to physical defects in the Software installation CD, contact Silhouette America. The Software CD will be exchanged in the case of a physical manufacturing defect, or a link to download the software will alternately be provided at Silhouette America's discretion.
- (2) Silhouette America only guarantees the CD under the above situation.
- (3) Silhouette America provides the Software on an "as is" basis. Neither Silhouette America nor the supplier guarantees the performance or results that may be achieved using the Software and accompanying documentation. Neither Silhouette America nor the supplier gives any explicit or implicit guarantees regarding the infringement of a third party's rights arising from the use of the Software or accompanying manuals, their commercial performance, or their suitability for specific purposes. Neither Silhouette America nor the supplier assumes any responsibility for incidental, secondary, or special damages resulting from the use of the Software or accompanying manuals under any circumstances, including cases in which the possibility of that particular damage arising is indicated to the User by the retailer. Moreover, neither Silhouette America nor the supplier assumes any responsibility for claims from third parties.

Registered Trademarks

The company names and product names described in this manual are registered trademarks of their respective owners.

Disclaimer

Some of the software images used in this manual are those that were used when the software was under development, and they may be slightly different from those actually displayed. There are no differences between the functions and setting layouts shown here and those of the actual version.

About this Manual

This manual is intended to provide an overview on how to use the Silhouette Studio® software. While other cutting devices may be compatible, this manual assumes the use of Silhouette electronic cutting tools. Instructions on using the Silhouette cutting tool may be found in subsequent manuals regarding the Silhouette hardware itself, including instructions on setting up the Silhouette for cutting or sketching, loading materials, and using the SD card feature (SD and Cameo models only) to cut directly from the Silhouette hardware device.

- (1) The contents of this manual may not be copied in part or in whole without permission.
- (2) The details and product specifications in this manual are subject to change without notice.
- (3) The greatest effort has been taken to ensure the clarity and accuracy of the information in this manual. Please contact Silhouette America or your retailer with any questions you may have.
- (4) Please note that Silhouette America assumes no responsibility for any liabilities arising out of the use of this manual and product.

1 - General Information

Silhouette Studio® is drawing/editing/output software that enables the creation of outline and print data consisting of objects and text, and the output of the created data to the Silhouette electronic cutting tool for a variety of applications including cutting and perforating media materials for 2-dimensional projects, fabricating 3-dimensional fold-together models from cut-out templates, and sketching line art. The software is compatible with all Silhouette models. The software also interfaces with other Graphtec plotter models CC100 – CC300 series models. Features and cutting results cannot be guaranteed for compatible plotter units or electronic cutting tools not offered by Silhouette America. Some features, such as Print & Cut applications, may not be available for other compatible cutting tools not offered by Silhouette America. Silhouette Studio® also supports convenient functions that enable the capturing of image data into the software and the automatic creation of registration marks for Print & Cut applications.

1.1 System Requirements

The following system environment is required to use Silhouette Studio®.

Operating System:

Windows – Vista/7 (32-bit & 64-bit)

Mac – OS X 10.6.8 or later

CPU: Pentium III 800 MHz or higher

Memory: 1GB RAM recommended

Monitor: 1024 x 768 True-color recommended (compact button mode available for notebook computers)

Mouse and/or Graphic Tablet

Supported cutting tool: Silhouette (original), Silhouette SD, Silhouette CAMEO®, Silhouette Portrait®, Silhouette Curio™, Craft ROBO, and Graphtec models (CC100, CC200, CC300/CC330, CC300L/CC330L)

Supported printers: Windows-compatible or Mac-compatible printers (inkjet printers strongly recommended for Print & Cut applications)

1.2 Features Overview

The Silhouette Studio® software includes, but is not limited to, the following software features and benefits:

- Imports a variety of file formats
- Print & Cut technology (requires printer)
- Download exclusive digital content
- Organize and optimize the library collection of images
- Cut font files already installed on your computer
- Manipulate Text with:
 - Word and letter wrapping
 - Alignment justification
 - Letter spacing control
 - Fit text to path
- Draw your own images in printing and cutting formats, including
 - Lines
 - Circles, Squares, and Rounded Rectangles
 - Polygons & Curved lines
 - Free-hand drawing tool
- Resize images to exact specifications
- Ungroup/Group sets of lines for manipulation
- Edit and manipulate points of text and images
- Erase image parts with freehand eraser tool
- Weld images together
- Create shadowed mat effects
- Arrange images with following abilities:
 - Transform
 - Rotate
 - Align
 - Replicate
 - Modify
- Manipulate line types for differing cutting actions
- Create your own Print & Cut images by filling images with custom colors, gradients, pattern fills
- Unlimited “Undo” and “Redo” actions

1.3 Software File Formats

The Silhouette Studio® software uses a proprietary .STUDIO file format, which consist of vector art for line and color/gradient fill type data intended for printing and/or cutting. The Silhouette also is able to open* the following vector file formats in a Ready to Cut format:

- GSD/GST (ROBO Master program files)
- DXF
- SVG (Designer Edition only)

The Silhouette Studio® software can also import some other vector and raster file formats for the purpose of being able to trace these images to create cut lines for Print & Cut images. The following additional file types can be imported:

- JPG
- BMP
- PNG
- GIF
- WMF
- PDF (Designer Edition only)

In addition to files that may be opened or imported, Silhouette Studio® can also access font. Please note that Silhouette cannot guarantee the quality or success of fonts not offered by our company as not all fonts are designed with cutting or sketching in mind.

You are also able to create your own images to cut with the Silhouette software. There are simple line drawing functions built into the Silhouette software that will allow you to do so from within the Silhouette program.

**Not all features of these file types may be able to be imported into the Silhouette Studio® software*

1.4 Available Digital Content

The Silhouette Studio® software comes preloaded with 50 ready-made designs. These become available as you connect and power on your electronic cutting tool.



Preloaded shapes will vary between Silhouette electronic cutting tools.

Additional content is available through the Silhouette Design Store (accessed through the Silhouette Studio® software). The store will allow you to access and purchase additional digital content for the software, available both from Silhouette artists as well as independent artists and various companies, thus ensuring a variety in look and feel of available premade content. Further information on the store and downloading content will be provided later in this manual.

2 - Installing Silhouette Studio®

2.1 Download

Silhouette Studio® is a free software download from silhouetteamerica.com. Follow the prompts to download the software to your computer. Make sure to choose the corresponding operating system (PC or MAC) to the computer you are using.

NOTE FOR WINDOWS USERS ONLY: Upon hooking up the USB cord from the Silhouette electronic cutting tool to your computer and powering on the Silhouette unit, you may be prompted with a "New Hardware Wizard" to install a driver. You may proceed to automatically find and install the driver as located on the installation CD. The driver is not required for proper operation of the Silhouette Studio® software, but may be installed to resolve the Windows automatic "Plug and Play" feature of prompting to install a driver for the hardware whenever the Silhouette is powered on.

3 - Basic Software Overview

3.1 Opening the Software

To open the software on PC, locate the desktop icon and double-click. If a desktop icon was not created during installation, go to the Windows Start menu and select to run Silhouette Studio®.

To open the software on Mac, open the Applications folder and launch Silhouette Studio®.

The Silhouette Studio® icon will appear as follows:



Once opened, the software should show an available starting document and workspace as shown below:

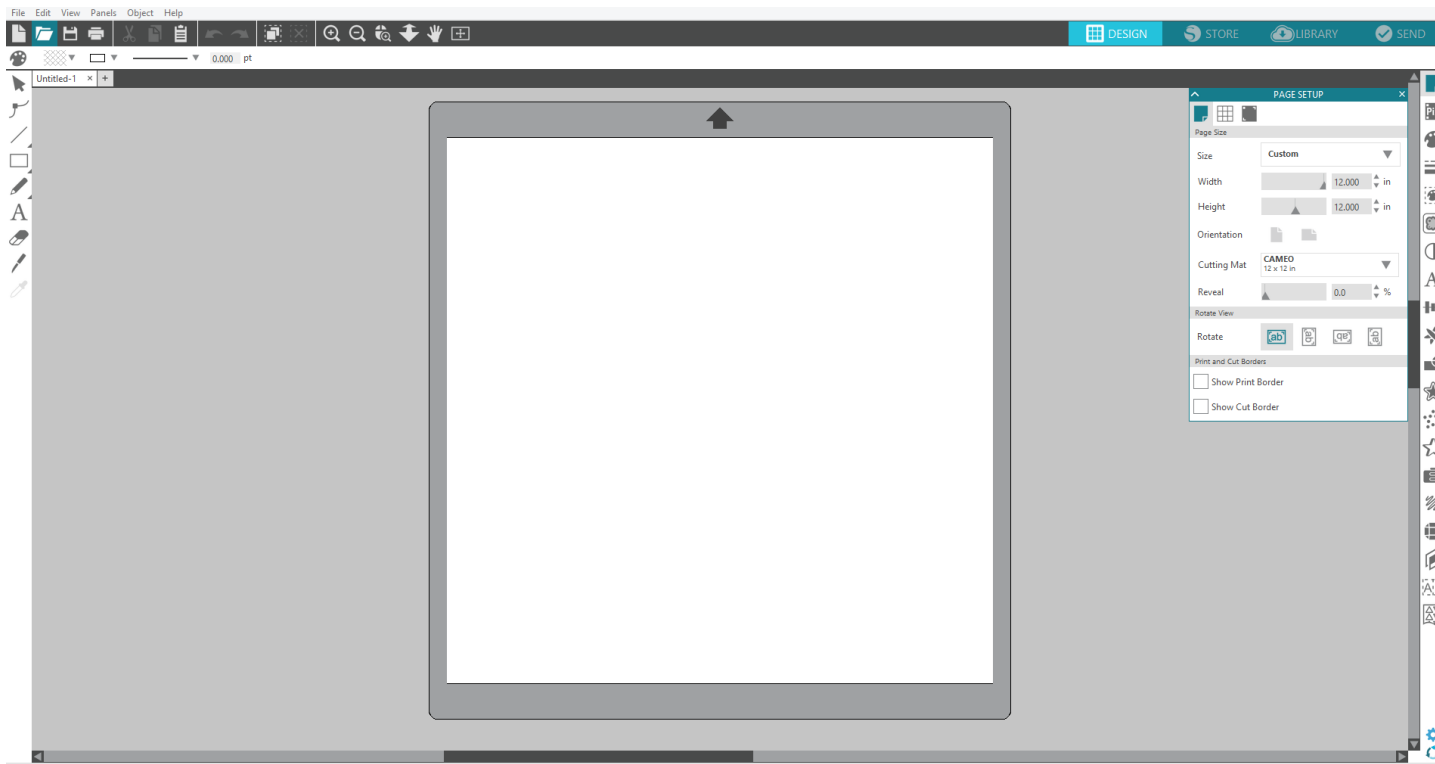

3.2 Software Sections

The software offers several sectioned areas. Details as to each button's specific function are discussed in later sections. However, so that you may be familiarized with where everything is located, a brief overview is provided for each of the sections.

General Document Management



This section along the top left-hand side of the screen is for general document management functions, such as opening, saving, and sending documents to a printer or your Silhouette electronic cutting tool.

Standard Editing Tools

This section along the top left-hand side of the screen is for basic copy/paste/cut and undo/redo actions commonly found in many programs.



Zooming Tools

This section along the top left-hand side of the screen is for basic zoom-in or zoom-out functions to view parts of the document from a closer perspective or at a more distant range.



Silhouette Studio® Tools

This section along the top right-hand side of the screen provides a range of tools for filling images, altering lines, adjusting text attributes, adjusting and replicating images, and adjusting page and cutting conditions.



Drawing Tools

This section along the left-hand side of the screen provides tools used for selecting, and drawing images as well as the ability to drop text directly into your workspace area.



Tabs

The tabs along the top right-hand side of the screen provide navigation to the Design page, Store, Library, and Send panel.



Quick Access Tool Bar

This section along the top of the screen provides a range of tools for grouping and selecting images, duplicating and deleting items, image placement priority (such as bringing images to the forefront or sending them to the back behind other images), welding, and offsetting.

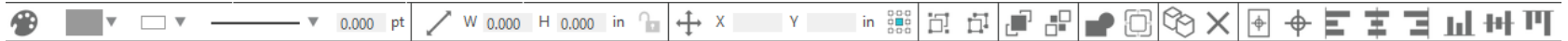

3.3 Cutting/Drawing Area

You will note there are two different sections in your workspace:



- White workspace
- Grey holding area

The white workspace notes the active document area. Images may be placed or drawn onto this area, or they may be placed or drawn in the grey holding area. Any images in this grey area are invisible to your cutting tool or printer. You may wish to place images off to the side to be set aside as you do not wish to include them in your job to be printed and/or cut.

You will note a red border inside this white workspace. The red line represents the active cutting area. The cutting tool will only be able to see and be able to cut what is inside this red line. All images being sent to the Silhouette to cut should be within this red line area.

3.4 Opening Documents



Though opening the software will always provide you with a new document, you may select a new workspace to start a new project at any time. To start a new document you may either use the New option from the File menu, or select the New icon:



To open existing files you may either use the Open option from the File menu, or select the Open icon:

You will then be prompted to navigate to the location where your desired file is located. Through the Open feature, the Silhouette Studio® software has the ability to open the following cutting-type files:

- STUDIO (Silhouette Studio® files)
- GSD/GST (Graphtec “ROBO Master” program files)
- DXF *
- SVG (Designer Edition only)

** Silhouette Studio® supports the following DXF features only: Arc, Circle, Ellipse, Line, DWPolyline, Spline, and Text*

The Open feature can also access simple image file types that are not in cutting format, but may be imported for printing or tracing purposes. When using a PC, you will need to select “All Files” under the type of file as you seek to open another type of file format.

A list of recently used documents may also be accessed from the File menu under Open Recent.

You may also use the Merge option from the File menu to open any file into the same workspace you are using rather than opening a new document workspace.

Finally, compatible file types may also be accessed by dragging the saved file from your computer directly onto your workspace in the software.

3.5 Document Tabs

Each new document or opened document will provide you with a new document tab at the top left-hand corner of your screen.

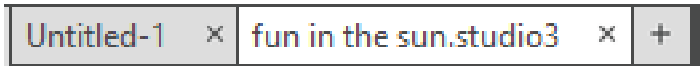

The tab will be labeled as “Untitled” until you save your file with a name, or if you have opened a file that already had a name, in which case the file’s name will be displayed. The white tab will always be the active document while all other opened inactive documents will be grey. You may click on any inactive tabs to make it the active workspace and toggle between open documents. Clicking on the “X” will close any open workspace.



3.6 Document Sizes

When a new document is opened, the default document size will always start at a standard Letter size (8.5" x 11") for the original Silhouette, Silhouette SD, and Silhouette Portrait® models or a 12" x 12" size for the Silhouette CAMEO® model.

To adjust your document size to another setting, you may either use the Page Tools option from the View menu, or select the Page icon:

The Page panel will allow you to alter the width or length of your document. There are pre-set common sizes you may select, or you may set measurements manually for any custom page sizes of material you may wish to use.

With custom page sizes the width may be adjusted up to a maximum 8.5 inch material width (original Silhouette, Silhouette SD, and Silhouette Portrait®) or a 12 inch width (Silhouette CAMEO®) depending on the cutting model used. The minimum recommended width for a custom size is 3 inches. The height may be adjusted up to any desired measurement. However, the maximum recommended height is 40 inches. While longer materials ranges may be selected, lengths exceeding 40 inches may have the possibility of becoming misaligned on the Silhouette machine's rollers as the cutting process continues beyond this maximum recommendation. The minimum recommended height for a custom size is 3 inches.

While viewing the Page Settings menu, if your material is sized to fit onto the cutting mat, the cutting mat will be displayed to help you see how your material may be placed onto the cutting mat to feed into the Silhouette when it is time to cut. Later, as you go to cut, this will also be displayed to help ensure you are feeding your material into the Silhouette correctly. This cutting mat animation may be selected to always be displayed under the Preferences settings (discussed in section 3.9).

When the cutting mat is shown, you may select the *Reveal Cutting mat* option in the Page Settings menu in order to show exactly on your mat where images will be cut in reference to the grid that is printed on the actual cutting mat.

Reveal  0.0 %

As you slide the bar to the right or increase the percentage number, the white page workspace will become more transparent and show the cutting mat beneath. A setting of 100%, or having this bar slid all the way to the right, will allow you to see the cutting mat completely and your white workspace will be entirely transparent.

When viewing in this manner, the red line will still represent your cutting area. Images falling outside of this red cutting area will not be cut. The darker area on the cutting mat represents your printer's print margin area and is only for reference.

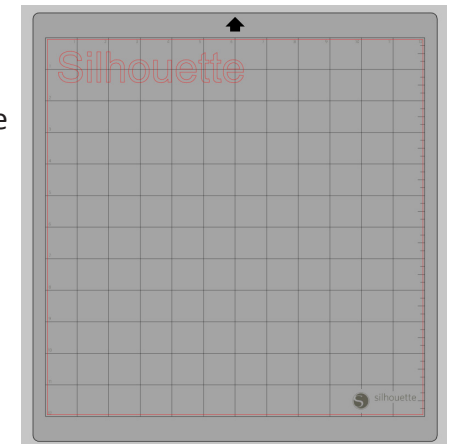

3.7 Cutting Orientation

Documents may be viewed in Landscape or Portrait orientation. Depending on how you may wish to view your workspace, images being sent to the Silhouette will vary based on your orientation.

Landscape is the default orientation whenever a new document is opened.



When a document is in landscape orientation, it will be sent to the Silhouette with the upper left-hand corner of the screen coinciding with the upper right-hand side of your material, as seen below:



Portrait orientation is an optional orientation that may be switched to through the Page Tools. Using this orientation will provide you with a screen that appears as the following:

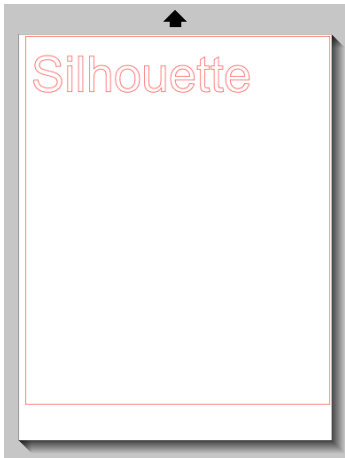

When a document is in portrait orientation, it will be sent to the Silhouette with the upper right-hand corner of the screen matching the upper right-hand side of your material, as seen below:



The Page Tools also provides the ability to rotate how you are viewing your page. While the Page Orientation will dictate the way your cutting job is being sent to the Silhouette to cut, the Rotate View option will simply rotate your workspace on the screen for a different perspective.

3.8 Viewing and Zooming

Often as you view your workspace, you may either wish to zoom in to get a closer look at smaller images or parts of an image that may be more difficult to work with.



Zoom In

This tool will zoom into the center of your workspace for a closer view.



Zoom Out

This tool will zoom out from your view for a more broad perspective.



Selection Zoom

This tool will allow you to zoom to specific areas of your workspace by drawing a box around the area you wish to zoom into.



Drag Zoom

After clicking on this tool, your icon will appear as the Drag Zoom icon above. You may then click and hold down your mouse to zoom in or out manually to any selected scale.



Pan

This allows you to move your entire workspace around.



Fit to Page

Clicking the Fit to Page icon will immediately fit the full defined workspace to the center of your screen.

3.9 Preferences

There are a number of user-controlled options that may be found in the File menu (PC) or Silhouette Studio® menu (Mac) under Preferences.

General

This section allows you to manually select the program language and how often you may wish the program to check for available software updates automatically. This section also provides preferences regarding units of measurement displayed in the program. You may adjust the following:

- Unit of Measurement – Adjust all displayed measurements to desired unit.
- Dimensions – Turn on or off image's measurement properties as images are selected.

Defaults

This section will allow you to adjust the default settings when Silhouette Studio® software is opened. You may adjust the following settings:

- Default Fill Style – Provides the ability to select how new user-drawn images are created as to whether they are displayed as an outline only (as red line images or grey line image), or as solid fill images (which may be preferable for the creation of Print & Cut images that are made by the user).
- Registration Marks Preference – Adjusts the program to default to have registration marks turned on or off.
- Page Orientation – Define whether Landscape or Portrait orientation is desired whenever a new document is started.
- Blade Type – Defines which cutting blade is being used with the Silhouette.
- Page Border – Gives the option to cut to the edge of your page.

Display

This section provides display options including:

- Antialiasing – Helps smooth jagged lines as they are created and viewed. Higher sample rates will increase the smoothness of lines. The “off” setting will produce rougher edges, but increases drawing speed.
- Button sizing – Allows for larger or smaller buttons to be displayed.
- Animation – Controls speed of animating actions, such as images being moved on undo or redo actions, or during zooming in and out. Can be adjusted to “Instant” to turn animations off.
- Background Color Preference – Allows you to determine the color of the inactive workspace area.
- Curve Quality – Enhances the visual appearance of lines on screen. Does not affect actual cut quality.

Import Options

Allows you to determine the behavior of various file types when opened.

Tools

This section provides preferences for how you may wish to view bezier control handles and how you would like images to behave when certain modifications are applied. It also provides preferences for adjusting how the program selects images or how various drawing tools either continue to draw or finish upon completion of using the drawing tools.

Advanced

This section provides additional advanced options. In this section, you may adjust the following:

- Restore Factory Defaults – Resets all preferences.
- Reindex My Library –Performing this action will re-index the library to ensure corruption or errors may be resolved should you experience any concerns with your library loading properly or being able to use the library’s Search function properly.
- Set Library Permissions – Allows library to be properly accessed according to computer account permissions.
- Restore Pre-loaded Designs –Restores pre-loaded designs according to the Silhouette model detected.
- Reset Library – This action will remove all images and folders from your library and reset the library back to its original software installation settings.
- OpenGL Settings – Attends to select display issues.
- HTTP Sockets – Depending on your internet connection speed, this option may be adjusted to a higher number of sockets to increase the download speed when purchasing images from the Design Store.
- IME Setting – Allows for typing of non-western characters.
- Proxy Settings – Used for proxy connection setups.
- Packet Size – Rate at which information is sent to the Silhouette.



Another program option not in the Preferences menu is the Software Color Theme button located in the bottom right-hand corner of the software screen.

Clicking on this button will cycle through a preselected list of color themes for the software’s overall appearance, should you prefer some color other than the default dark grey interface.

4 - Drawing/Editing Images

4.1 Basic Drawing Tools

Silhouette Studio® allows users to draw and create images very easily through a set of basic drawing tools. All drawing tools are located on the left side of the software screen.



Line Tool

The Line Tool allows for the creation of single straight lines. Holding down the Shift key on your keyboard while drawing will force a straight vertical, horizontal, or 45° increment line from the start point.



Polygon Tool

The Polygon Tool allows for the creation of multiple straight lines. A point will be created upon each mouse click. Lines will continue to be drawn until the image is closed by aligning the end point with the starting point, or by double-clicking the mouse to stop drawing. Holding down the Shift key on your keyboard while drawing will force a straight vertical, horizontal, or 45° increment line from the start point or last point dropped.



Curved Shape Tool

The Curved Shape Tool allows for the creation of multiple curved lines. A point will be created upon each mouse click. Lines will continue to be drawn until the image is closed by aligning the end point with the starting point, or by double-clicking the mouse to stop drawing.



Arc Tool

The Arc tool allows you to draw any size arc on your page.

**Rectangle Tool**

The Rectangle Tool allows for the creation of a square or rectangle. Holding down the Shift key on your keyboard while drawing will create a square, while holding down the Alt key on your keyboard will make the initial cursor point where your image is started as the exact center of your object.

**Rounded Rectangle Tool**

The Rounded Rectangle Tool allows for the creation of a square or rectangle with rounded corners. Holding down the Shift key on your keyboard while drawing will create a rounded square, while holding down the Alt key on your keyboard will make the initial cursor point where your image is started as the exact center of your object. As a rounded rectangle is selected, you will find two red control points on the rectangle's upper left-hand corner. These may be dragged to adjust the curves of the rectangle's top and bottom or sides, or you may select both simultaneously by holding down the Shift key on your keyboard and dragging one of the control points.

**Ellipse**

The Ellipse Tool allows for the creation of an oval or circle. Holding down the Shift key on your keyboard while drawing will create a circle, while holding down the Alt key on your keyboard will make the initial cursor point where your image is started as the exact center of your object.

**Regular Polygon**

The Polygon Tools allows for creation of shapes of different number of sides. The default number of sides is five, but the slider bar in the middle provides a method of raising or lowering the number to produce different shapes, such as a triangle.

**Freehand Tool**

The Freehand Drawing Tool allows for the creation of a continuous free-form line. Lines drawn with this tool will continue until the mouse button is released, or the image is closed by aligning the end point with the start point.

**Smooth Freehand Tool**

The Smooth Freehand Drawing Tool allows for the creation of a smooth, continuous free-form line. Lines drawn with this tool will have smooth transitions and no sharp angles. Lines drawn with this tool will continue until the mouse button is released, or the image is closed by aligning the end point with the start point.

4.2 Editing Images

All line points on images may be edited, if changes to the existing image are desired.



Select Tool

The Select Tool determines which image is selected as the active image and allows you to move images around on your screen. This is your default tool to click on images to show they are selected.



Edit Points

To enter the Point Editing Mode, you may either double-click on a selected image, or use the Edit Points tool. This tool will allow you to edit any points of your image to move them around or remove them. Only single ungrouped line selections may be edited. Ungrouping will be discussed in later sections.

To exit the Point Editing Mode, you may double-click on your image again, or return to the regular select mode by clicking on the Select tool.

Point Editing Mode

When you enter the Point Editing Mode, selected images will change from displaying the resizing and rotating control handles around the image to showing the points, or nodes, of the image. Points on lines are where the line may take a new direction or change from being flat (or straight) to being curved.

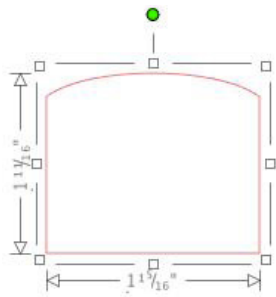

Regular Selection Mode

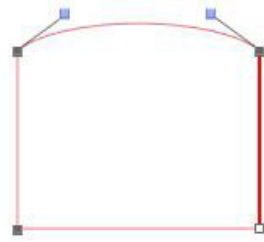

Point Editing Mode

In Point Editing Mode, the selected point will be displayed in white while all other points will be dark grey. The selected line associated with the selected point will be emphasized as a bolded red line. Additional lines that have blue points are handles to adjust curved lines.

In Point Editing Mode, you will also be shown the Point Editing toolbar on the right-hand side of the screen. You may do the following actions in Point Editing Mode:

Move/Adjust Points

Move a point by hovering with your mouse over any point on the line. Once over a point that may be edited, the cursor will adjust to show you may click and grab the point to move it to any desired location. With curved lines, you may similarly grab the blue points and drag them around the screen to adjust the curve of the associated line segment.

Add Points

Add a point by hovering over the line where no points currently exist where you may wish to drop a new point to edit your image. Once over a line where a point may be dropped, the cursor will be adjusted to show you may click to drop a point onto the desired line location.

Aside from the tools found in Point Edit Mode, there are two additional editing tools found on the left-hand side of the screen.



Delete Point

Any selected point will be deleted by using the Delete Point tool, or by right clicking on the selected point and choosing the Delete Point option. Deleting a point will cause the closest points on either side of the deleted point to join and create a new connecting line. Note that this tool is different from deleting an image and is only intended to delete individual points. It will only be available while in Point Editing Mode.



Break Path

You may break the path of any line point by using the Break Path tool, or by right clicking on the selected point and choosing the Break Path option. Breaking a path will create two new points from the originally selected point where the path was broken.

You will note that a broken path, or two unconnected end points of opposite ends of the same line, may be re-joined by dragging one end point onto the opposite end point of the image.

**Corner**

The Corner tool will allow a selected point to be so that the control handles at the selected intersecting point can be adjusted each individually to create a sharp corner.

**Smooth**

The Smooth tool will allow a selected point to be adjusted to make a smooth transition point at the selected intersecting point.

**Make Flat**

The Make Flat option will adjust the selected line (the line emphasized in bold red that is associated with whichever currently selected point) to a flat, straight line.

**Make Curve**

The Make Curve option will adjust the selected line (the line emphasized in bold red that is associated with whichever currently selected point) to a curved line.

**Simplify**

Some library images or other imported images from other sources may contain a very large number of points. The Simplify tool will automatically re-adjust the image's points and simplify the image to its simplest possible point form while maintaining the image's original overall line form.

Aside from the tools found in Point Edit Mode, there are two additional editing tools found on the left-hand side of the screen.



Eraser Tool

You may erase any part of any image using the Eraser tool to easily and immediately remove inner parts or edges of the line image. The Designer Edition of the software features several options for eraser shapes and allows you to choose between creating an open or closed eraser path.

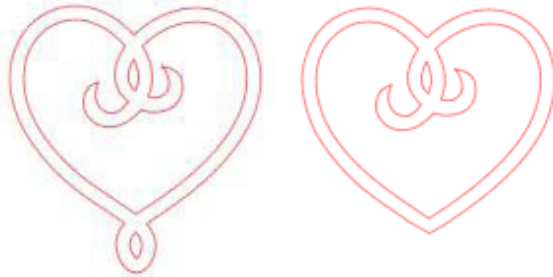

Original Image

New Image Using Eraser Tool



Knife Tool

You may segment images using the Knife tool. This tool delivers a straight-line cut to separate parts of images to create a new separate independent shape. The Designer Edition of the software features several options for knife path shapes and allows you to choose between creating an open or closed knife path.

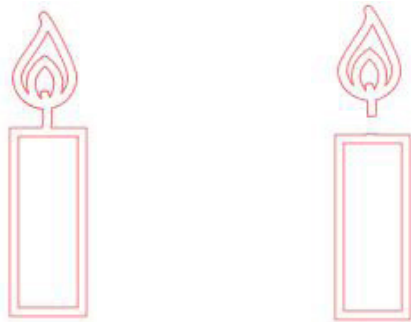

Original Image

New Image Using Knife Tool

4.3 Line Tools

Lines in the program, including text, images created using the drawing tools, and library images, may be altered to have different properties.

Line Color Options



While lines will default to be displayed in red, you may alter lines to any desired color. Altering line colors will not affect their properties in how they may cut. Altering line colors may be helpful to allow you to more easily view different images or image parts, see lines in whichever color you may prefer to view them, or adjust image parts specifically with printing in mind for Print & Cut jobs where it may be important that line colors are selected to be printed.

To adjust line colors, select your image and access the Line Color menu by clicking on the icon shown above. You may then select any of the Basic Menu color options. The hash line selection will always represent “clear”. The color picker tool will allow you to select any color from another object in the drawing area to duplicate the desired color.



Clear



Color Picker

The Advanced Options menu will allow you to create lines in any desired custom color. You may either drag the target on the color spectrum to visually match the color you are looking for, or type in the RGB (Red Green Blue) or HSL (Hue Saturation Lightness) value of your desired color. You will also have the ability to adjust the Transparency of the line.



Line Style Options

Within the Line Style menu, you may adjust the style of your line to be a solid (default) or dashed style line. Lines will accordingly be cut or printed in the selected style.

Lines are viewed in point sizes regarding their width. The point size may be adjusted to any desired specification. While line width may be adjusted, the line will always be cut or sketched in a fixed width; that is, according to how thick the blade or pen is that you are using.

Line thickness may be adjusted by either manually dragging the Thickness option bar or by typing in the desired point thickness.

The Corner Style option will adjust how lines appear at any of the image's corner points where Corner is a sharp edge whereas Rounded will be a smoother edge.

The End Cap Style option will only adjust lines that have open ends. Flat or Square provide varying sharper flat edges at the line tip whereas Rounded provides a smoother rounded edge to the line tip.

The Position option will adjust if the line is In Front of a filled image, or Behind the filled image.

4.4 Fill Tools

Closed images (where the starting point of the line connects with the ending point of the line) including Text, images created using the drawing tools, and library images, may be altered to have different filled properties. Only closed images may have filled attributes. If the path is broken on any closed images, any applied fill attributes will immediately disappear.



Fill Color Options

While closed images will default to be displayed as empty, you may fill any closed image with any desired color. Altering fill colors may be helpful to allow you to more easily view different images or image parts, see shapes and text in whichever color you may prefer to view them, or adjust images specifically with printing in mind for Print & Cut jobs.



To apply fill colors, select your closed line image and access the Fill Color menu by clicking on the icon shown above. You may then select any of the Basic Menu color options. The hash line selection will always represent “clear”. The color picker tool will allow you to select any color from another object in the drawing area to duplicate the desired color.



Clear



Color Picker

The Advanced Options menu will allow you to create fill colors in any desired custom color. You may either drag the target on the color spectrum to visually match the color you are looking for, or type in the RGB (Red Green Blue) or HSL (Hue Saturation Lightness) value of your desired color, if you are seeking a specific known color. You will also have the ability to adjust the transparency of the filled color by manually dragging the Transparency option bar or by typing in the desired percentage of how transparent you wish the filled color to be, where 0% is solid and 100% is completely clear.

Fill Gradient Options

Similar to filling images with solid colors, you may also select to fill any closed line images with a gradient fill.

To apply gradient fill options, select your closed line image and access the Fill Gradient menu by clicking on the icon shown above. You may then select any of the Basic Menu precreated gradient options. The hash line selection will always represent “clear”.



Clear

You may also alter the basic direction of the gradient by clicking on any of the Direction options at the bottom of the Basic Options panel.

The Advanced Options menu will allow you to create your own custom gradient fills based off of the last gradient fill selected. Gradient fills will always have a minimum of two colors, with one color at the top and one color at the bottom. The gradient will then create a range between the two selected colors.



You may change either of these colors in the range by clicking on the color arrow bars on the left-hand side of this gradient creator tool. Once the color is selected, you may then select any new color from the Select Color tools directly below. You may also add new bars at any interval between the top and bottom colors, or slide any color bars in between the top and bottom gradient color bars up and down to create new gradient effects.

Also in the Advanced Options is the ability to rotate the angle of the gradient effect to any customized degree by either manually dragging the Angle tool or by typing in a specified degree. You will also have the ability to adjust the transparency of the line by manually dragging the Transparency option bar or by typing in the desired percentage of how transparent you wish the filled gradient effect to be, where 0% is solid and 100% is completely clear.



Fill Pattern Options

The final fill option is used to fill any closed line images with a pattern fill. To apply pattern fills, select your closed line image and access the Fill Pattern menu by clicking on the icon shown above. You may then select any of the pattern options.

Once your desired pattern fill is selected, the Advanced Options menu will allow you to adjust the pattern's direction Horizontally or Vertically, or adjust to either a Fixed or Stretch aspect ratio. Options are provided in this menu to rotate the pattern by either simple preset degrees, or to any customized degree by either manually dragging the Angle tool or by typing in a specified degree.

In addition, you have the ability to scale the pattern's size to alter the pattern itself as it fills the selected shape. You may do this by either manually dragging the Scale Pattern bar or entering a new percentage value of how much larger or smaller you may wish to make the filled pattern.

You will also have the ability to adjust the transparency of the line by manually dragging the Transparency option bar or by typing in the desired percentage of how transparent you wish the filled gradient effect to be, where 0% is solid and 100% is completely clear.

Additional patterns may be downloaded from the Silhouette Design Store.

You can create patterns from your own images by going to File > Import > Import Options. Navigate to the image you would like to use and select it. A new dialogue box appears where you can add information about the image. Press OK to add the image to the User Designs folder in your library. From there, you can drag your image onto any fillable shape on your workspace.

**Shadow Options (Designer Edition only)**

You can add and adjust a shadow by clicking the Shadow icon in the toolbar above the workspace. In the Shadow menu, you can adjust the shadow offset, color and transparency.

**Sketch Options (Designer Edition only)**

Create a sketch design by clicking the Sketch icon in the toolbar above the workspace. In the Sketch menu, you can adjust the sketch edge, fill type, and fill effect.

**Rhinstone Options (Designer Edition only)**

Create a rhinestone design by clicking the Rhinestone icon in the toolbar above the workspace. In the Rhinestone menu, you can choose a rhinestone effect, rhinestone size and spacing, and placement options. For advanced rhinestone options, see the 'Designer Edition Plus Features' section.

5 - Text

A Silhouette Studio® has the ability to utilize any font that is installed on your computer. You do not need to install these fonts into the program. Silhouette Studio® will simply access all installed font files and display them for you as you go to create your desired text.

5.1 Creating Text

To use your fonts, click on the text tool located on the left-hand side of the software screen.

Clicking this will allow you to place a text cursor onto your workspace and begin typing directly onto the screen.



The red blinking line is your cursor to show where you are typing. You may back up or move forward by either clicking your mouse or using your computer's right and left arrow keys.

The surrounding green box is your text box. This box may be adjusted by clicking and holding the black bar on the right edge of the text box. Dragging this bar to the left will allow you to wrap your text. Dragging this bar to the right will allow you to bring text back toward being on a single linear path.

You may double-click or click outside of the text to exit the Text Editing Mode. You may return at any time to re-edit any words or letters by double-clicking again on your created text.

5.2 Manipulating Text

During the creation of your text, the Text Style menu will be opened on the right-hand side of your screen providing multiple adjustment options.

Available Fonts

The first section of this menu will display the current selected font with additional font options that are installed on your computer you may scroll through. The top of this section may be used to search for any specific font by typing in a font name if it is known.

You may change fonts during the Text Editing Mode and use a new font within the same text box with other fonts. Different fonts may also be applied to existing text or letters during Text Editing Mode by highlighting the desired string and selecting the newly desired font. If you are not in Text Editing Mode, new fonts may still be applied to selected text, but such adjustments will change the font for the entire selected text box.

Font Characteristics



B Bold
I Italic
U Underline

Some fonts are programmed to enable the use of certain style characteristics allowing you to bold, italicize, or underline text or letters. These characteristics will only be highlighted to be available for selecting if the font in question is programmed with that characteristic and such characteristics can be applied. To apply one of these characteristic, you may highlight the intended letters or words and then click on the available characteristic.

While Bold, Italic, and Underline options are displayed, if there are any additional available options programmed for the selected font, a scroll bar will appear on the right-hand side of this option box allowing you to scroll down and view whatever other options may be programmed.

Text Justification



While text will be automatically be justified to the left, if your text is wrapped on multiple lines, you may alter your text justification as desired.

Text Size

Text size will always default to 72 point size. This refers to the font's printed font size. Though fonts vary as they are programmed by a wide variety of sources, this will generally equate to roughly a one (1) inch height (or 25 mm). The most common point sizes for print-format fonts are included in the available drop-down list, though any custom number may be manually typed into this size preference.

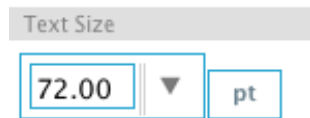

Other common equivalent measurements in the list include:

- 18 pt = 0.25 inch (6 mm)
- 24 pt = 0.33 inch (8 mm)
- 36 pt = 0.5 inch (13 mm)
- 48 pt = 0.66 inch (17 mm)
- 144 pt = 2 inches (50 mm)
- 288 pt = 4 inches (100 mm)

Again, these measurements are approximations and will vary from font to font, so if you are seeking to obtain a specific measurement, you may wish to alternately re-size your text to your desired specification after creation.

Character Spacing

Letters may be adjusted from their normally programmed spacing to either bring them closer together or push farther apart with the Character Spacing option.



Spacing will always start at 100% indicating spacing between characters are normally distanced. As the number is lowered or the bar is slid to the left, letters will come closer together. As the number is raised or the bar is slid to the right, letters will become spaced farther apart.

Line Spacing

If your created text is wrapped to multiple lines, you may similarly increase or decrease the Line Spacing option to adjust the distance between lines of text.



Spacing will always start at 100% indicating spacing of lines are normally distanced. As the number is lowered or the bar is slid to the left, text lines will come closer together. As the number is raised or the bar is slid to the right, text lines will become spaced farther apart.

5.3 Text to Path

As text is created, or while in Text Editing Mode, you will find a control point located on the left-hand side of the text being created:



This control point may be dragged to rest directly on any line path within your workspace. For example, you may create an oval with the Ellipse tool and then drag your text onto this line to achieve an arced effect:

As text is applied to a path in this manner, you will note a vertical bar to the left of the text. This allows for a new control bar which can be used to adjust the placement of your text relative to the line onto which the text has been applied so that it may be placed on, above, in line with, or below the path.

Note also that the object used as a path will turn grey. This indicates that this image is now turned off for cutting purposes. If you wish to re-enable the object being used as a path to cut, you may visit the Cut Style Options as previously discussed and select Enable Cut Style as the grey path object is selected.

6 - Manipulating Images

There are many tools in Silhouette Studio® allowing for basic and advanced manipulation of images and text. The following section provides an overview for all of these included tools and how they may be used.

6.1 Basics

Like most any software program, Silhouette Studio® has a set of common basic editing tools as follows:

Selecting

Images may of course be selected by clicking on them. Multiple images may be selected by holding down the Shift key on your computer keyboard and clicking on another image. You may repeat this action to select as many images as desired. Holding down the Shift key and clicking on an image that is already selected will deselect that image.

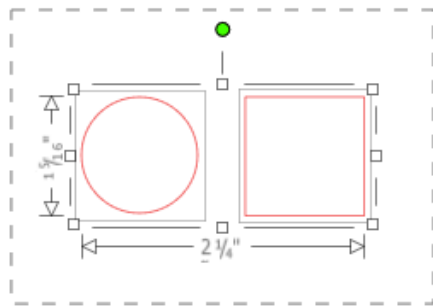

Multiple images may be also be selected by clicking above an image and dragging your mouse to enclose all desired shapes to be selected at the same time. As you hold your mouse button down and drag your mouse, you will see a dashed line creating a selection box showing what you are selecting. Upon letting go of your mouse, all enclosed images in this box will be selected together in the same bounding box.



If you wish to select all available images on the screen together, you may click on the Select All button located in the Quick Access Tool bar.



If you wish to select only those images that are the same color, you may click on the Select by Color button located on the right-hand side.



If you wish to deselect all currently selected images, you may click on the Deselect All button located in the Quick Access Tool bar..



Cut, Copy, and Paste Tools

These tools perform the basic expected actions of copying selected images, pasting them, or cutting them from view. Images copied or cut will reside in your computer's memory on a virtual clipboard. You may only have one object on this clipboard at a time. This means if you copy one image and then copy another, only the most recent image will be waiting on the clipboard to be pasted. These actions may be accessed from the top tool bar, in the Edit menu, or by right-clicking on an image, as well as by using standard shortcut keys for these actions.

Pasting copied images will place the copy directly to the right of your original image so you may easily see and find your copy. An additional Paste in Front option is also provided to be able to paste a copy of an image directly on top of itself and is found in the Edit menu, in the right-click menu for the selected image, or by using standard shortcuts for this action.



Duplicate

The Duplicate option performs the same action as copying and pasting the selected image to the side, but does so without the need of utilizing your clipboard and is a one-click operation. This toolbar button is located at the top of the software screen and can alternately be located in the Edit menu or by right-clicking on a selected image.



Delete

Selected images may be deleted from your workspace by clicking on the Delete button located at the top of the software screen, by accessing the Edit menu and selecting Delete, right-clicking a selected image and choosing the Delete option, or by simply pressing the Delete key on your computer keyboard.



Undo/Redo

Any action taken, including simply moving an image, may be undone. To back up to the previous action taken, click the Undo button. There are an unlimited number of actions you may go back to with the Undo button, including going back to when you first opened your new workspace.

Similarly, you may click the Redo button to repeat any actions you may have undone. You may continue to use this button until you return to the last action taken.

***Transfer Properties (Designer Edition only)***

Properties such as line color and cut style can be transferred from one shape to another by selecting the shape you want to transfer properties to, selecting the Eye Dropper icon in the left-hand tool bar, and then clicking on the shape you want to imitate.

***Layers (Designer Edition only)***

When you import a project with layers created in another program, you can access those layers in the Layers panel. You can also use the +/- keys to add or remove layers in Studio.

6.2 Grouping/Ungrouping

These two actions are commonly used and are invaluable tools for helping to manipulate and adjust images. To understand these concepts we must first understand what grouped and ungrouped images are.

The following is an example of a single line:

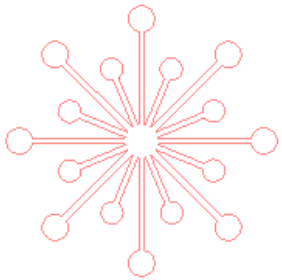

While the image may have many parts, it is still just one line with a single starting point and end point.

The following is an example of a multiple line image:



This image has two line sets with the body of the leaf and stem being one part and the inner details of the leaf being another. This image is grouped together so that if moved around on your screen, you do not have to move the outer line of the leaf and then move the center part independently and try to align it inside.

While it is not necessarily important to know exactly how many line parts an image has, it is important to understand that single line images are not grouped together with anything, while anything that has multiple parts is or can be grouped.



Grouping

Any two sets of lines can be grouped together so they are fixed in their relative positions, even if moved, by using the Group option.

To use the Group option, select two or more images at the same time and click on the Group icon located in the Quick Access Tool bar. This can alternately be located in the Object menu or by right-clicking on the multiple selected images and selecting Group.



Ungrouping

Any image that contains more than one line set can be ungrouped so that parts of the image may be treated independently, removed, rotated, resized, or otherwise manipulated rather than having to manipulate the image as a whole.

For example, you may wish to cut out this cake image, but want to ungroup the image in order to remove some of the inner decorations of the image:

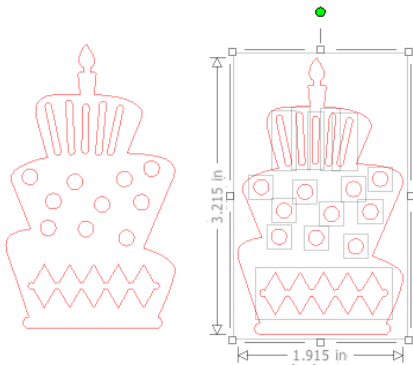

Once ungrouped, the image will be displayed showing individual selection boxes around each new ungrouped image part that can now be manipulated:

To access the individual ungrouped parts, you may unselect your image.

6.3 Compound Paths

The concept of compound paths is important in order to understand why certain attributes may be applied differently to seemingly identical situations. Compound paths are a collection of two or more line sets where inner lines are embedded into the image. A compound path may appear the same as a grouped set of lines, but is quite different in the way it will react to being filled with color, for example.

Compound paths are only really a concern when you are creating Print & Cut images.

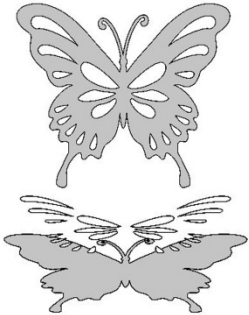

Non-compound Image

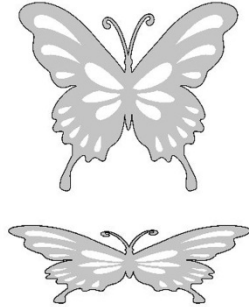

Compound Path Image

In the previous examples, the top two images are seen straight on and appear to be identical. However, when looking at the bottom set of images the differences become apparent. With the image on the left, from a side view we are actually looking at a grey butterfly with white spots resting on top. This is an image that is not a compound path. With the image on the right, from a side view we see that we are looking at a grey butterfly with white spots embedded into the image.

Of course, as we go to cut or sketch both images with the Silhouette, they will cut out in the exact same manner, but it is important to understand that there is a difference between these images as you may wish to achieve certain effects with filling images for Print & Cut applications.

For example:



This is the same image unfilled. All parts are grouped together.

If this is a non-compound image and it is filled with a color feature, this will be the result:



Even though grouped together, all line sets are still just individual pieces lying on top of each other, so they are all filled with the selected fill effect.

If this image has a compound path and it is filled with a color feature, this will be the result:



The unfilled parts of the image cannot be filled with compound path images because these embedded areas are negative space.

Compound paths can still be ungrouped to move multiple image parts around, but the action of ungrouping will immediately release the compound path and make it a non-compound path image

To make a series of multiple selected images a compound path, you may right-click until the multiple parts are all selected and select Make Compound Path. Similarly, you may right-click on a compound image and select Release Compound Path to perform the opposite action. These options may also be found in the Object menu.

6.4 Moving Images

Images may obviously be moved by selecting them and then dragging them around the screen with your mouse to any desired location. Selected images may also be moved by using the arrow keys on your computer keyboard.



You may also move images through the Move menu panel.

Selected images may be moved by using any of the Move options. The directional arrows in this screen will move images subtly in whichever direction you select. This action may be repeated until your image is located on your workspace as desired.

The Move By option will move selected images from the current location by whatever measurement is entered, while the Move To option will move images regardless of present location to a specific plotted course on your workspace, where a measurement of 0, 0 (zero, zero) represents the upper left-hand corner of your workspace and moves out from that point either to the right or downward as the values increase.

6.5 Rotating

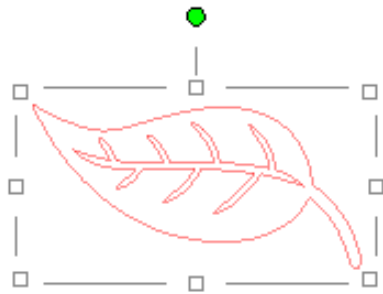

Objects may be rotated to any desired angle. Selected images will always appear with a green rotation handle-bar that may be manually grabbed and rotated using your mouse.



The Rotate menu options will also provide additional rotation options for more exact or specific rotation options.

Within the Rotate menu you may select any of the following options.

Rotate By

These options will rotate the selected image by the selected common angle from the image's current angle.

Rotate To

These options will rotate the selected image to the selected angle based on the image's original fixed 0° point.

Custom Rotate By

This option will allow you to either manually slide a degree measurement bar or enter a specific degree measurement and apply to rotate the selected image from the image's current angle.

Custom Rotate To

This option will allow you to either manually slide a degree measurement bar or enter a specific degree measurement and apply to rotate the selected image based on the image's original fixed 0° point.

Center of Rotation (Designer Edition only)

To adjust the point around which your shape rotates, you can adjust the center of rotation. To do so, select the shape you want to rotate, press the letter 'O' on your keyboard to display a small cross-hair icon in the center of the shape. You can then move the cross-hair icon to the desired new point of rotation.

6.6 Sizing

Objects may be sized to any desired measurement. It is important to note, however, that while you may customize images to any desired size, the quality of cuts made may vary, especially when cutting thicker materials such as cardstock. Reducing the size of an image with intricate parts and cutting it in a thicker material is an example where the cut quality could suffer.

You will be able to view the measurement alongside your image as you draw or select images.

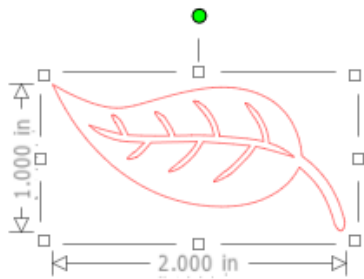

There are also control points on the selection box for resizing images manually. To resize manually, simply click on any of these boxes and drag your mouse in the desired direction to make your shape larger or smaller. The corner control points will proportionately resize the image and maintain the relative height and width, while the side control points will stretch your image in the direction your mouse is dragged.



The Scale menu options will also provide additional sizing options for more exact or specific rotation resizing options.

Within the Scale menu you may select any of the following abilities.

Scale

These options will resize any selected images by a percentage of its current size. Any number under 100% will make your image smaller and any number over 100% will make your image larger. For example, selecting to resize your image to 50% of the current size will make your image half as large while selecting to resize your image to 200% of the current size will make your image twice as large. Any custom percentage may be applied as desired.

Specify Dimensions

This option will allow you to resize a selected image to any specific measurement. The Lock Aspect Ratio option when checked will ensure your image is resized proportionately when only one measurement is being altered but you wish to maintain the image's proportions. For example, if we take our original leaf example that started at 1 inch height by 2 inches width and adjust the width to 1 inch, you can see the following results:

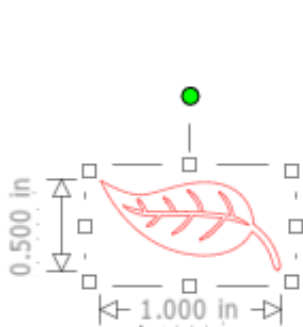

With Lock Aspect Ratio

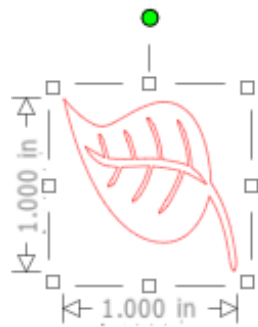

Without Lock Aspect Ratio



Shear (Designer Edition only)

Use Shear to skew your design vertically or horizontally. You can select from preset amounts or specify a custom shear.

Grid



To assist with viewing measurements, you may also opt to turn on the grid by either right-clicking on your workspace while there are no images selected and clicking on Show Grid, or by going to the Grid menu.

In the Grid menu you may turn the grid on and off, adjust the grid spacing to any desired measurement, and define the number of divisions in the grid.

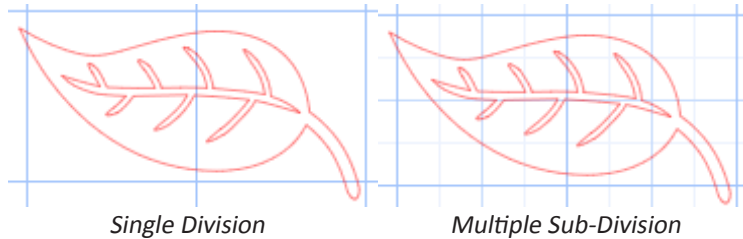

The Snap to Grid option when enabled will force the image to conform to grid's measurement and divisions. This may be especially helpful when drawing images to force them to conform to specific desired measurements.

The grid's Style may be selected to be either a traditional Square grid or an Isometric grid. Again, the different styles may be helpful while drawing images within the software to provide a reference for measurement as you draw.



The grid's Color can also be adjusted as desired and offers a preselected set of color suggestions which may provide a non-intrusive appearance for your grid, though any custom color may, of course, be selected.

In Designer Edition, you also have the ability to activate Rulers and Crosshairs to help make layout easier.

6.7 Mirroring

Some materials or situations require images to be cut in a mirror image format, or you may simply want to flip objects around to achieve your desired image appearance.

To mirror an image, you may right-click any selected image to select the Mirror Horizontally or Mirror Vertically option.

Silhouette etteuorli2

No Mirror Effect

Mirrored Horizontally

2!ipno!te etteuorli2

Mirrored Vertically

Mirrored Horizontally and Vertically

Further mirroring options may be accessed in the Object menu under the Transform sub-menu listed as Mirror Options.

In this menu, you may likewise flip your images around (as displayed above) under the listed Flip menu options.

You may additionally create mirror copies of selected images with the Mirror menu options, where you may create a mirrored copy to the left, to the right, mirrored above, or mirrored below.

To mirror an image, you may right-click any selected image to select the Mirror Horizontally or Mirror Vertically option.



Original Image

Mirror Copy Above

Mirror Copy Below



Mirror Copy Left

Mirror Copy Right

6.8 Arranging

Multiple images may overlap each other. The order of which image is in front and which is in back can be arranged. This is mostly used with filled images for Print & Cut applications so you can determine which image should be in front of the other.



Bring to Front

This option will take your selected image and move it in front of all other overlapping images.

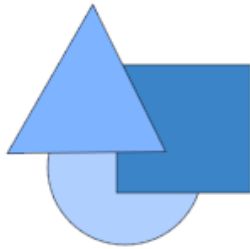

Original Image Order

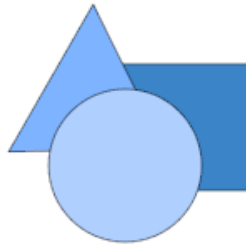

Circle Selected and Brought to Front



Send to Back

This option will take your selected image and move it behind all other overlapping images.



Original Image Order

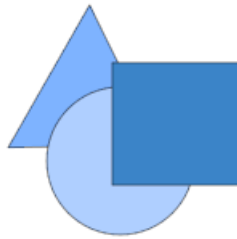

Triangle Selected and Sent to Back



In addition to these options, you may also right-click on an image and select Send Backward to send the selected image one level back rather than all the way to the back.



Original Image Order

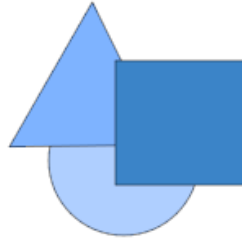

Triangle Selected and Sent Backward



Similarly, you may right-click on an image and select Bring Forward to bring the selected image one level forward rather than all the way to the front.



Original Image Order

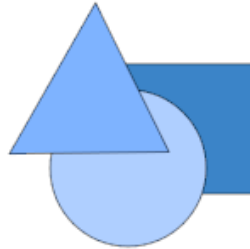

Circle Selected and Brought Forward

6.9 Aligning



Multiple images may be aligned in relation to each other. The following Align options are available:

Centralize (Align Center-Middle)



This option will center two or more selected objects so that they are lined up with each other in the middle of each other.

Align Left



This option will align two or more selected objects so that they are aligned together to the left edge of the shared bounding box while maintaining their respective distances in regard to being above or below each other.

Align Center



This option will align two or more selected objects so that their center points are aligned together while maintaining their respective distances in regard to being above or below each other.

Align Right



This option will align two or more selected objects so that they are aligned together to the right edge of the shared bounding box while maintaining their respective distances in regard to being above or below each other.

Align Top

This option will align two or more selected objects so that they are aligned together on the top edge of the shared bounding box while maintaining their respective distances in regard to being next to each other.

Align Middle

This option will align two or more selected objects so that their center points are aligned together while maintaining their respective distances in regard to being next to each other.

Align Bottom

This option will align two or more selected objects so that they are aligned together on the bottom edge of the shared bounding box while maintaining their respective distances in regard to being next to each other.

Space Horizontally

When a minimum of three objects are selected, this option will take all images and space them horizontally so that all objects are equidistant from each other horizontally.

Space Vertically

When a minimum of three objects are selected, this option will take all images and space them vertically so that all objects are equidistant from each other vertically.

6.10 Replicating



Replicating while similar to copying and pasting an image or duplicating it allows for the ability to create any number of copies and place them at once without the need to copy and paste the images multiple times and then have to place them manually around the screen as desired. These options will also create copies next to each other as closely as possible to maximize your cutting area.

You will find the following options in the Replicate options basic menu.

Duplicate Left

 This option will duplicate the selected object and place a copy directly to the left with the most minimal amount of space between the objects as possible.

Duplicate Right

 This option will duplicate the selected object and place a copy directly to the right with the most minimal amount of space between the objects as possible.

Duplicate Above

 This option will duplicate the selected object and place a copy directly above with the most minimal amount of space between the objects as possible.

Duplicate Below

 This option will duplicate the selected object and place a copy directly below with the most minimal amount of space between the objects as possible.

Row of Three / Row of Four

These options will copy the selected object and replicate two or three additional copies next to each other in a row, stacked horizontally next to each other, with the most minimal amount of space between the objects as possible.

Column of Three / Column of Four

These options will copy the selected object and replicate two or three additional copies next to each other in a column, stacked vertically on top of each other, with the most minimal amount of space between the objects as possible.

Rotate One Copy / Two Copies / Three Copies / Five Copies

These options will copy the selected object and replicate one through five rotated copies on top of the original image.

Fill Page

This option will copy and replicate the selected object and fill the cutting area with as many copies possible.



In the Replicate menu, you may also access an Advanced Options menu. Here you will have the option to select any desired number of copies to replicate your selected image and the distance between these replicated images, including the ability to select any custom direction. Once the desired number of copies and direction has been selected, you may click on the Replicate button at the bottom of the Advanced Options menu to apply the selected attributes.

**Object to Path**

This option allows you to take one object and place it on the path of another object. Once it is on the path, you may make copies and duplicate the object by simply pulling on the control handles.



6.11 Nesting (Designer Edition only)

To minimize the space required to cut a certain design, the Nesting feature can be used. You can choose to use your entire media surface to nest your shapes or create a specific area for them to nest in.

Use Cut Area

If you choose to Use Cut Area, your entire media surface can be used to nest shapes.

Use Selected

If you would like to nest your shapes within a certain area, first draw that area on your workspace. Next, click on Use Selected in the Nesting menu. Nesting will occur within this defined area.

Select all the shapes you would like to nest. In the Nesting menu, you can adjust the rotations and padding of the shapes to be nested. Increasing rotations and/or decreasing padding will yield a tighter nest.

After making any necessary adjustments, click Nest and the shapes will nest together to maximize space. If you have selected more shapes than will fit in the nesting area, the software will determine which shapes fit best in the defined area.



6.12 Modify

Overlapping images may be altered in a variety of ways. The Modify menu options provide welding and other advanced options to allow overlapping images to be adjusted.

Within the Modify menu you may select any of the following abilities.



Weld

While the Weld option may be found in the Modify menu, there is also a quick access button located along the bottom tool panel of the software screen. Welding will take two or more selected overlapping images and join them together into one single continuous image.

Silhouette

Non-welded image with overlapping lines

Silhouette

Welded image with overlapping lines removed

Welding can be particularly useful when cutting so that the cut lines don't overlap during the cutting process.



Subtract All

This option will remove any portion of an image that is in back behind another image.



Original Image



With Subtract All Applied

**Divide**

This option will create individual images from the intersections of up to eight selected images.



Original Image



With Divide Applied

**Subtract**

This option will remove all overlapping parts of images that are in front of other images, so that only the image located in back will remain with the overlapping parts removed.



Original Image



With Subtract Applied

**Intersect**

This option will leave only the overlapping part, or intersecting part, of the selected images when applied.



Original Image



With Intersect Applied

**Crop**

This option will remove all areas that are not shared by at least two shapes when overlapping.



Original Image

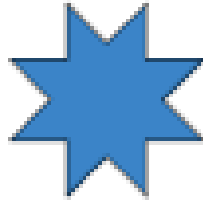

With Crop Applied

**Compound Paths (Make / Release)**

These options are the same options previously discussed in the section 6.3 regarding Compound Paths. This tool will take overlapping embedded images and either Make them into a compound path or Release the compound path.

**Detach Lines**

When images are filled or have thick lines defined, this option may be used to detach and move the outline to create two separate images; one with just the lines and one with just the filled effects left behind.



6.13 Offset Options

The Offset option may be used to outline cut-line images giving the image a shadowed mat effect underneath it. It may also be used to create contoured inner lines for images.

To apply offset conditions, you will first need to select an image.

The word "Silhouette" is written in a large, light red, outlined font.

Original Starting Image

Within the Offset menu you may start by selecting the offset action.

You may select to either have your offset image have a sharper Corner appearance, or have a softer more bubbly Round appearance.

Though clicking the offset action button provides a starting point, you may fine tune the offset effect to any specified Offset Distance with the slider bar, or by typing in a specific measurement.

At any point your desired effect is achieved you may set the properties of the newly created image into place by clicking Apply.

The word "Silhouette" is written in a large, light red, outlined font with a noticeable gap between the original text and the offset outline.

Offset Image

You may conversely create an internal offset condition.

This feature is generally better suited for the creation of internal lines for use with sketch pens.

The word "Silhouette" is written in a large, light red, outlined font with a thin, light red line following the inner contour of the letters.

Internal Offset Image



6.14 Tracing Options

Tracing options can be used to automatically trace imported external images for the purpose of creating cut lines. Silhouette cannot guarantee the quality of images not created by our company nor support any third-party images not offered through the Silhouette Design Store. Silhouette Studio® should not be used to trace licensed or copyrighted images which you do not specifically own.

Once you have opened an external image you own (as discussed in Section 3.4), you may open the Tracing options and then click on Select Trace Area. This will allow you to draw a box around the intended area of your imported image you may wish to trace. This selection area once drawn may be adjusted or moved like any other object in the program as you may need to expand or refine the trace area. The trace area selection will provide a preview of the original image with a yellow area overlay where the trace area would be applied according to the Trace Settings filters. These filters will provide a more refined or more liberal application of the intended traced effect depending on the settings selected.

Once the desired tracing effect preview is achieved, you may then opt to apply the trace method by selecting one of the following:

Trace

This option will provide a traced line contour around all parts of the yellow preview area displayed.

Trace Outer Edge

This option will create a traced line around the outer edge of the yellow preview area displayed only and ignore any inner parts that may otherwise be displayed in yellow showing a potential tracing path.

Trace and Detach

This option will trace the outer edge of the yellow preview areas of the image and detach them from the rest of the background of the raster image.



Trace by Color (Designer Edition)

This will trace a single area filled with a solid color. Check 'Trace all areas with same color' to trace all instances that color appears.



Magnet Trace (Designer Edition)

This will give a magnet tool that will cling to an image while it is being traced. Each mouse click will result in a magnet trace point added to the image. Once the image has been traced, the remaining background will be cropped out.

7 - Library and Design Store

Silhouette Studio® offers a library feature to keep and categorize all of your downloaded and user-created image for easy reference, as well as an Design Store to provide new content for users to download.

The library and store views may be found in the top tabs of the software screen and show which panel of Design, Store, Library, or Send is the current selected active tab.

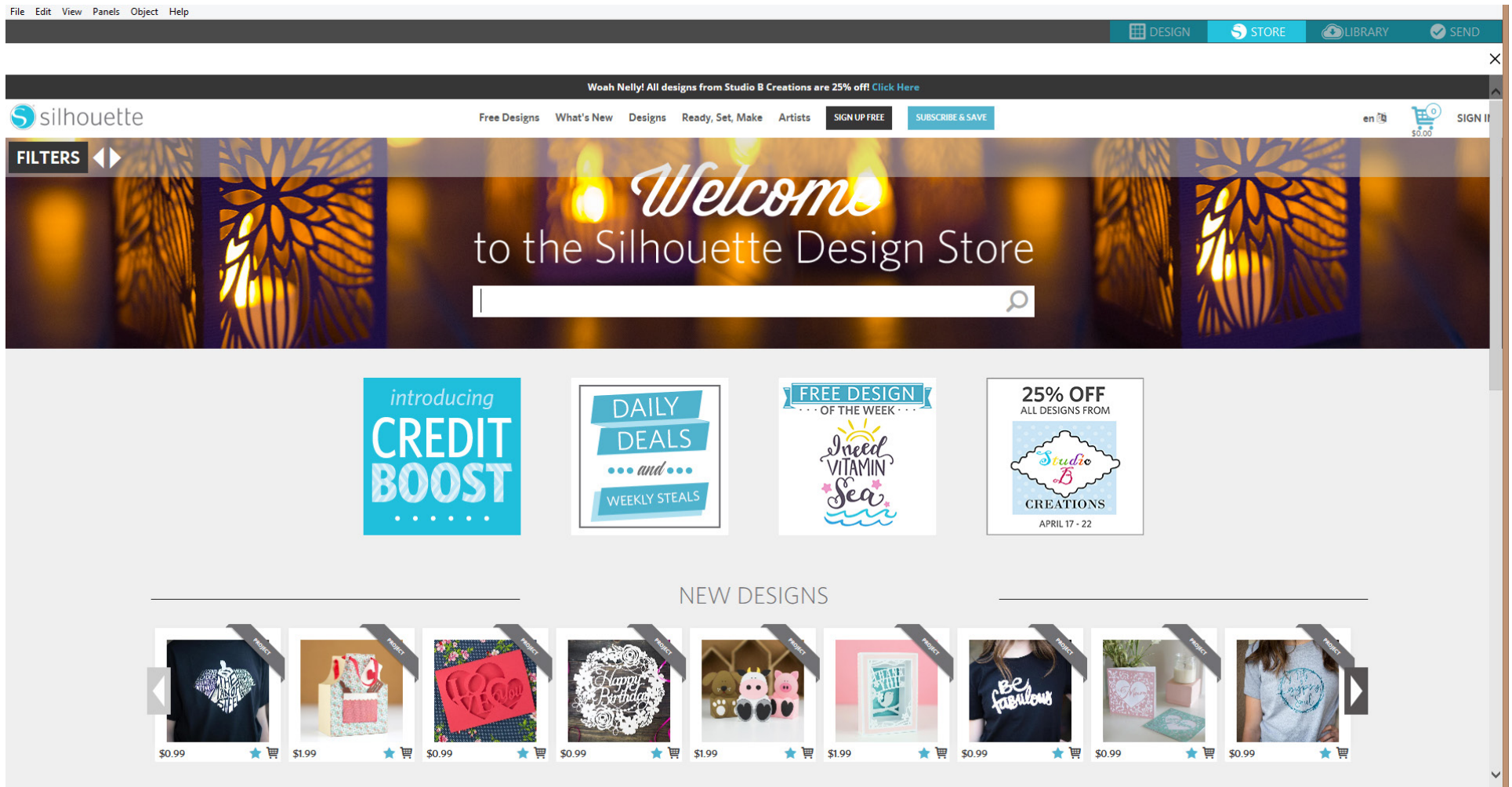

7.1 Library

The Library is where all of your preloaded and purchased content is contained and may be categorized, sorted, and accessed.

Viewing



You are able to view your images as icons by clicking on the Icon View option:



You may alternately view your library images in a list view to see more detail by clicking on the List View option:

In List View mode you may sort your images by Name, Category, Artist, Date Downloaded, or Size by clicking on these column header titles.

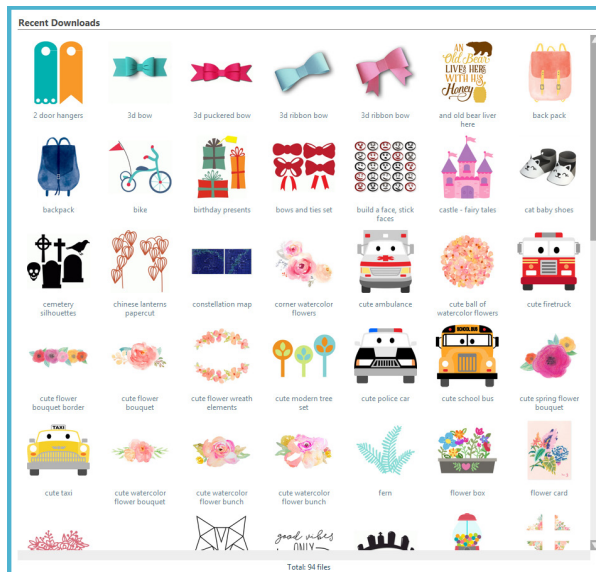

Library in Icon View mode

Name	Date Modified	Category	Artist	Type	Size
2 door hangers	4/7/2017	Regular Cut	Loiri Whitlock	studio	29.2 KB
3d bow	4/7/2017	3D Crafts	Felicity Jane	studio	47.1 KB
3d puckered bow	4/7/2017	3D Crafts	Jamie Cripps	studio	30.5 KB
3d ribbon bow	4/7/2017	3D Crafts	Alaxi K	studio	27.3 KB
3d ribbon bow	4/7/2017	3D Crafts	Alaxi K	studio	34.2 KB
and old bear liver here	4/18/2017	Regular Cut	Megan Hardy Designs	studio	150.4 KB
back pack	4/11/2017	Print and Cut	Dear Lizzy	studio	157.9 KB
backpack	4/11/2017	Print and Cut	Dear Lizzy	studio	174.4 KB
bike	7/13/2016			studio	48.3 KB
birthday presents	4/7/2017	Regular Cut	Jennifer Wambach	studio	54.5 KB
bows and ties set	4/7/2017	Regular Cut	Sophie Gallo	studio	56.1 KB
build a face, stick faces	4/7/2017	Regular Cut	Snapdragon Snippets	studio	201.9 KB
castle - fairy tales	4/7/2017	Regular Cut	Doodlebug Design	studio	61.2 KB
cat baby shoes	4/7/2017	3D Crafts	Tanya Batrak	studio	152.2 KB
cemetery silhouettes	4/18/2017	Regular Cut	Michelle Renee	studio	43.7 KB
chinese lanterns papercut	4/4/2017	Regular Cut	Nic Squirrel	studio	101.4 KB
constellation map	4/11/2017	Print and Cut	Dear Lizzy	studio	874.8 KB
corner watercolor flowers	4/11/2017	Print and Cut	Angie Makes	studio	136.8 KB
cute ambulance	4/11/2017	Regular Cut	Studiollustrado	studio	43.6 KB
cute ball of watercolor flowers	4/18/2017	Print and Cut	Angie Makes	studio	710.1 KB
cute firetruck	4/11/2017	Regular Cut	Studiollustrado	studio	43.2 KB
cute flower bouquet border	4/11/2017	Print and Cut	Angie Makes	studio	577.4 KB

Library in List View mode

Accessing Library Content

To access library images, you may:

- Double-click on your image to open it onto your workspace
- Drag images from your library onto your workspace (only if your workspace is being displayed)

Categorizing & Library Management

As your library continues to grow with additional content, you may find it convenient to customize your library with new folders and sort images according to your liking.

You may add new custom folders by right-clicking and selecting “New Folder”.

As new Untitled Folders are created, you may immediately name your folder to the desired name. Once your new folder has been created, you may drag and drop images into the folder. Right-clicking on a folder will allow you to create a new sub-folder for that selected folder, delete the folder (along with all contained content), or rename the folder.

In addition to customizing folders, you may also adjust any of your images within the library. Right-clicking on an image will allow you to delete the image, re-name the image, sort the images in the current folder, or show/hide the images properties. Image properties will provide you with the image’s description (as downloaded from the Design Store) and display any associated keywords.

As images or folders are deleted, they will be moved into the library’s Recycle Bin. You may still restore any of these images or folders by dragging them back into your library. However, once you have deleted any content from your Recycle Bin, this content will be permanently deleted from your computer.

7.2 Silhouette Design Store

The Silhouette Design Store provides additional downloadable content from not only Silhouette, but also a variety of independent artists and contributing companies. The Silhouette Design Store can only be accessed from within the Silhouette Studio® software and requires an internet connection.

The Store is accessible at any time, 24 hours a day, 7 days a week.

While images may be purchased individually to customize your library experience, subscription options are also available for a monthly fee. Further information on subscriptions may be found in the Silhouette Design Store.

All images are provided with the following benefits:

- You may download images using any major credit card, through download cards, or by using subscription credits
- Indefinite usage (you do not have to be connected to the Internet to access once purchased)
- Recoverable (in case of computer crash or replacement)
- Resizable and customizable to your specifications (using Silhouette Studio® tools discussed in previous sections)

Download Cards

Silhouette offers download cards which provide download credit valid toward any of the store's download content you may wish to purchase and add to your library. You will find two codes on the back of each card. In the lower right-hand corner is the card's identification number. Behind the silver security strip is the actual download code. It is a 16-digit code.

Logging into the Store

Upon accessing the Silhouette Design store by clicking on the Store tab, you will be brought to the store's homepage.

The screenshot shows the Silhouette Design Store homepage. At the top, there is a navigation bar with tabs for 'DESIGN', 'STORE', 'LIBRARY', and 'SEND'. Below this, a banner reads 'Welcome to the Silhouette Design Store' with a search bar. The main content area features several promotional tiles: 'introducing CREDIT BOOST', 'DAILY DEALS and WEEKLY STEALS', 'FREE DESIGN OF THE WEEK' (I need VITAMIN Sea), and '25% OFF ALL DESIGNS FROM Studio B CREATIONS APRIL 17 - 22'. Below these is a 'NEW DESIGNS' section displaying a carousel of various design projects, each with a price tag and a star icon.

You may sign in, or sign up for an account if you do not already have one created, by clicking on the link in the upper right-hand corner noting that "You are not signed in".

To create an account, you will need to provide your name, your email address (which will be your login name), and any desired password.

My Account Options

Once logged into your account, you will find a link in the upper right-hand corner called My Account which will provide you with tools to manage your account. You will have the following options:

Change My Account Information – This will allow you to alter your email and password.

My Download History – This will allow you to view a copy of all orders placed. When viewing specific orders, you may also opt to recover a specific order if there was any break in connection during the download process.

Recover All Downloaded Designs – This will allow you to recover any and all previously downloaded content if you are seeking to load the software onto a new computer in the case your computer has crashed or you are simply replacing your computer.

Add a Download Card to My Balance – This is where you may enter any download card codes to apply the available balance onto your account.

Manage My Credit Cards – Allows you to manage any credit card information on file used to pay for subscriptions or individual purchases.

Downloading



You may continue to browse and add additional images until you are ready to check out. Once you are ready, you may either click on the my cart link in your mini cart preview, or click on the cart icon in the upper right-hand corner of the shopping window.

When you are ready to download, simply click the Checkout button. If you have a balance on your account from a download card or subscription credit, the total charges will be taken from your balance automatically. If you do not have a balance or your account balance does not cover the total of the images you are seeking to purchase, you will be prompted to either provide credit card information or add a download card code to your account.

Once ready, you will be prompted for your password to authorize your purchase. Upon entering your password to confirm the purchase, the library will appear in a panel above the store and you will be able to view your images as they are downloaded into your library.

RECENT DOWNLOADS



hi speech bubble

You may then continue to navigate through the Design Store, or close it as desired. Once your images are all downloaded, you may then drag them from the recent download section and sort them as desired into any of your library folders. Downloaded images will remain in this Recent Downloads folder until sorted.

You will note that while all purchased images are stored in your library, purchased fonts will also be referenced in the library in a special “My Fonts” section. You may then either access these fonts purchased through the Design Store by double-clicking on these from the library, which will bring you to your workspace with a text cursor ready to place to type, or by access your fonts as previously discussed in section 5.

Recovering Images

Silhouette America maintains a database of all Silhouette users and their download histories. In the event of a computer crash or computer replacement, after re-loading the software onto your new computer, you may log into your Silhouette user account with your email address and password. Once logged into your account, you may go to the my account options to select Recover All Download Designs.

If you have multiple computers you own (such as a desktop and a laptop) and are simply seeking to recover your most recently purchased images to a secondary computer, rather than using the Recover All option, you may visit your My Download History in your account options to access a list of your previous purchases. In this section, you may click on any previous order number and recover your order. Again, you may only perform individual order recoveries to a limited number of computers which you expressly own.

Using the recovery features will not, of course, recover any user-created designs you may have created. Only downloaded images purchased through the shopping section may be recovered. You may back-up your user-created designs by simply locating where you have saved your user-created files and saving them onto a disc or other storage device.

Silhouette America does regulate the number of unique computers you log into and reserves the right to suspend or remove accounts of registered Silhouette users whose account activity may be suspicious or indicative of public file sharing.

Silhouette Cloud

Silhouette Cloud works hand in hand with Silhouette Studio® Mobile to keep all of your designs synced on multiple devices. You can sync up to five devices with your Cloud account. If you aren't using multiple devices, Silhouette Cloud is useful in backing up your designs and preventing the need for recoveries.

In Silhouette Cloud, there is unlimited storage available for Silhouette Design Store downloads. There is 1GB available for custom content. Club Silhouette Members receive 5GB of storage for custom content.

To sync your files, drag them into the cloud icon in your Library folder. The software will prompt you to sign into the Cloud with your Silhouette account. Once you sign in, your Cloud will start syncing your designs.

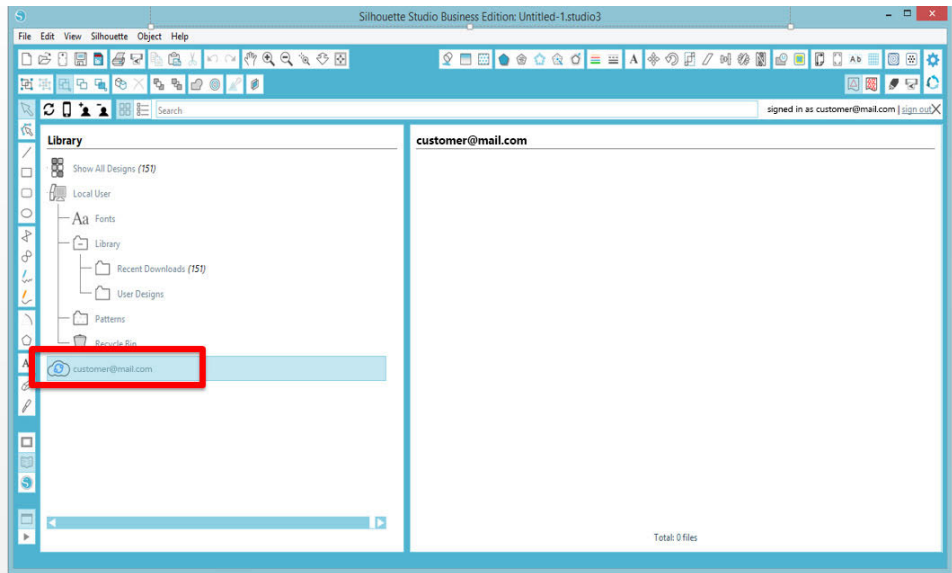
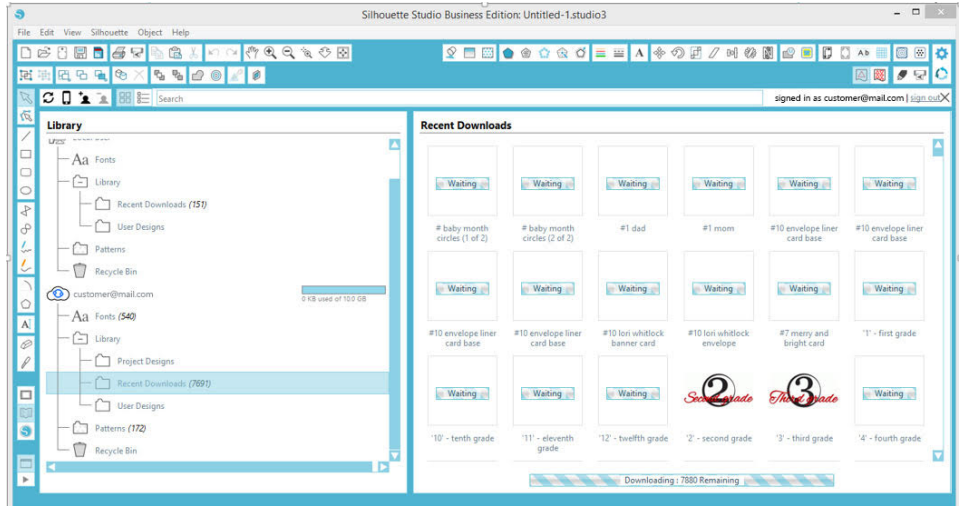

Your Cloud Library will remain its own folder in your Library. You have the option to save things under your Local User folder or into your Cloud Library, which is titled with your Silhouette Account email. Files saved in your Local User folder will only be available from that device.

To manage your Cloud Devices, go to your Account Options in the Silhouette Design store.



8 - Saving

After you have created an image or document layout, you will have a variety of options to save your images.

Save

The Save option is the basic saving function to allow you to create a STUDIO file and save to any location on your computer. These files may be backed up on any removable memory device.

Save As

This option found in the File menu will allow you to name your image as it is saved. It is saved to any specified location on your computer and can be backed up to a removable or external memory device as desired.

Save Selection

This option found in the File menu will save a STUDIO file of only the actively selected images from your document. It is saved to any specified location on your computer and can be backed up to a removable or external memory device as desired.

Save to Library

This option found in the File menu will save your file into the Library in Silhouette Studio®. Upon selecting this option, you will be prompted to enter the name, keywords (which will become searchable upon re-indexing the library, as found under the Advanced Preferences), a description, the artist, and the shape's category type. Upon saving images to your Library, they will be added to a section labeled User Designs in the Library. These images cannot be navigated to on your computer for manually backing them up, so it is highly recommended to also save a copy of any images using the regular Save option.

Import to Library

This option differs from the Save to Library option in that this option will allow you to browse to an image on your computer to import it into your library, rather than saving an image you have created from within the software.

9 - Cutting/Sketching

9.1 Send

Once you have all desired images and/or text on your workspace ready to cut or sketch, you may select the Send tab.

Material

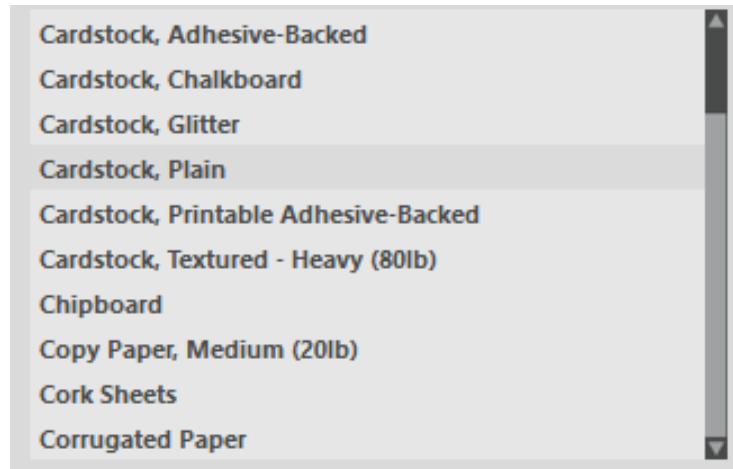

In the Material menu, you will be provided with a list of common materials that can be cut with the Silhouette as well as all specialty materials offered from Silhouette. Click on a material from the list to select it.



You may add User Defined media types into this list by clicking on the plus sign in the media list, and likewise remove any unwanted material types by clicking on the minus sign.

When you select a material type from the list (or create your own), recommended cut settings will appear in the Action panel. If you need to adjust these settings for your specific material, you may do so. Your changes will be saved for future projects, so it is generally preferable to create custom settings rather than altering existing settings.

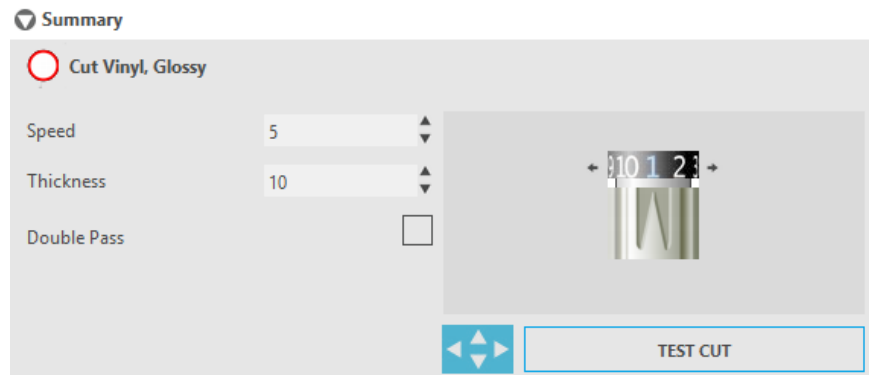

Action By: Simple

In Simple Cut Mode, all lines are scheduled to cut at the same time. Cut lines can be turned on or off individually, but cannot be sorted to cut in a specific order.

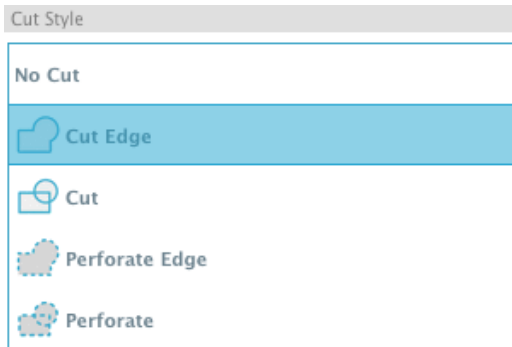

In Simple Cut Mode, you can adjust the Cut Style of individual lines in your project. When clicking on this option, your workspace will immediately emphasize all lines and their selected attributes for easy reference. To change a line's cut style, simply click on the desired image and then select the new desired line style from the list. The following line styles are available:

No Cut – This option will turn off the line from being sent to the Silhouette. While you will still be able to see it on your screen, it will be suppressed from being cut.



Cut – This option ensures the selected line will be cut regardless of where it is placed, whether overlapping or inside a larger image. Lines with this attribute will cut even if they are contained within other lines that are defined as “Cut Edge” or “Perforate Edge” line types.



Cut Edge – This option will cut the outer edge of any overlapping lines and will suppress any lines with the same attribute if they are contained inside a larger image. This option may be preferable for the creation of Print & Cut images.

Action By: Line Color, Fill Color, or Layer

You have the option to break up your project into multiple stages. This is especially handy if your project is designed to be cut in several colors or with projects that are to be sketched and then cut out. You can schedule cuts by line color, fill color, or by layer (Designer Edition only).



By Line Color - All of the line colors present in your project will be visible in the cut menu. Based on line color, you can turn cut lines on or off, activate or deactivate auto-weld, and arrange a cutting order.



By Fill Color - All of the fill colors present in your project will be visible in the cut menu. Based on fill color, you can turn cut lines on or off, activate or deactivate auto-weld, and arrange a cutting order.



By Layer (Designer Edition Only) - All of the layers present in your project will be visible in the cut menu. Based on the layers you've created, you can turn cut lines on or off, activate or deactivate auto-weld, and arrange a cutting order.



Turning cut lines on or off - You can turn cut lines on or off by checking (or unchecking) the box next to the cut color or layer.



Turning auto-weld on or off - You can turn auto-weld on or off by clicking the auto-weld box next to the cut color or layer. With auto-weld activated, overlapping shapes of the same color or layer will be welded together.

Arranging cutting order - To arrange the order that different colors or layers are cut, simply click and drag the desired color or layer to a higher or lower in position in the cut order.

Adding pauses - Pauses are especially helpful in sketch projects where it is necessary to change pens or blades between colors. To schedule a pause after a color or layer is finished, right-click (control-click on a Mac) the color or layer and select "add pause".

Blade Setting Recommendation – Though the software and actual Silhouette unit will not know what blade level you are actually using, the recommendation will provide you with a visual cue on what blade setting should be used for the intended media based on the blade type for your cutting tool model. The Sketch Pen selection refers to Silhouette sketch pens that fit directly into the Silhouette unit where the blade would usually be loaded and is intended to be used when sketching rather than cutting.

Speed – The Speed is measured in centimeters per second x 10. In other words, the Silhouette can cut from 10 centimeters per second up to 100 centimeters per second. To achieve the best results, slower speeds may be recommended for thicker materials or designs that are more intricate.

Thickness – The Thickness is measured in approximately 7 grams force per setting and has 33 levels. In other words, the Silhouette can cut from 7 grams up to 230 grams force. Thicker materials will likely require higher Thickness levels.

Double Pass – This check box will have the Silhouette cut through all lines present in your cutting area twice. It may be necessary when cutting thicker materials in order to obtain a cleaner cut.

Cutting Mat – This check box notifies the program as to whether or not you are using the Silhouette's cutting mat (sticky cutting mat). This option may only be selected for material sizes that do not exceed the ability to load materials onto the cutting mat. Many specialty material types offered by Silhouette America will have their own backing and so do not require the use of the cutting mat. However, if your material is either too narrow to be gripped by the rollers or does not have its own adhesive backing, you must check this option.

Track Enhancing – This check box notifies the program that you wish to enable the Track Enhancing feature, which will roll your material into the Silhouette and back out several times prior to cutting in order to create a track where the rollers are gripping the material in order to ensure the material stays on track during the cutting process. This option should only be used if it is already pre-selected for your material type or if you are having issues with a specific material type slipping during cutting and causing the resulting cuts to be misaligned.

Line Segment Overcut

Once a material type is selected, you will find a Line Segment Overcut option that can be turned on or off by clicking on the desired option:



Selecting the “Off” option will have all lines cut normally. Selecting the “On” option will have all straight corners cut with a slight overcut. This option is beneficial for providing cleaner cutting results in the following conditions:

- Cutting thicker/denser material types (such as chipboard)
- Cutting smaller block fonts or sharp-edged images on various material types

The option will have no effect on rounded edges. It is only effective for images containing sharp edges in order to achieve the best cutting results possible under the conditions listed above.

Advanced Cut Setting

The Advanced Send menu offers several options for specialized cutting with your Silhouette.

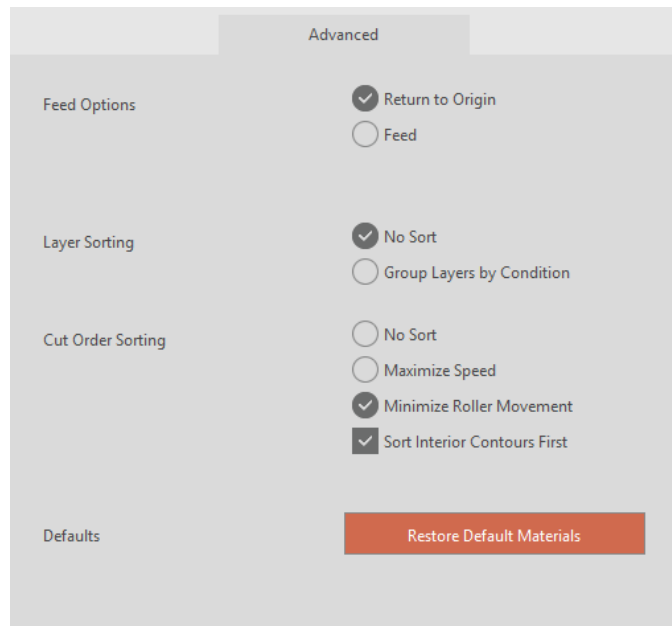

Feed Options - The Return to Origin option will simply return the material back to the original starting point after the job is completed. The Feed option will continue to feed the material forward beyond the original point of origin.

Layer Sorting - The No Sort option will retain your images as originally laid out while the Group Layers by Condition will sort your images according to any layers that exist in the document.

Cut Order Sorting - This series of options allows you to control the cutting order of your job. The No Sort option will not take any special order action and will simply cut your images according to their layout. The Maximize Speed option will set the cutting order to cut the job as quickly as possible. The Minimize Roller Movement option will cut the job according to the least amount of back and forth roller movement possible to aid in the cutting more delicate materials where decreased roller movement may be beneficial. The checkbox option for Sort Interior Contours First allows you to control whether the interiors of images will be cut first (checked), or if the interior is simply cut in line with all other portions of the image during the cutting process (un-checked).

9.2 Performing a Test Cut

When going to cut a new material type you have not previously cut, whether it be a pre-defined media-type setting or a new User Defined media type you are trying to find the correct settings for, it is advisable to perform a Test Cut in order to ensure your settings are correct and you will be able to obtain a clean quality cut for your intended job. You can access the Test Cut options in the Send menu.



To perform a Test Cut, click on the Blade Position Arrows to move your blade so that it is resting over your loaded material in the Silhouette unit.

Once your blade is in position where you wish to make a small cut, you may click on the Test Cut button. The Silhouette will then cut a small square with an embedded triangle so that you may gauge your results and determine if any settings need to be adjusted. You may continue to make further test cuts until results are to your satisfaction.

9.3 Cutting / Sketching

Once you have selected the correct settings and are ready to send the active workspace to the Silhouette, you will want to ensure your material has been loaded properly and that you have selected the correct blade setting for cutting, or that you have loaded a pen in the case you are sketching.

Please refer to the “Silhouette Quick Start Guide” received with your Silhouette for further instruction on proper blade and cutting mat preparation with your Silhouette electronic cutting tool.

When using the Cameo model you will also want to make sure you have adjusted the rollers to the proper distance setting according to whether you are using a cutting mat or according to the media size being used. The Send panel will instruct you which roller setting to use if you are unsure. Again, please refer to the “Silhouette Quick Start Guide” for further information on how to adjust the Cameo rollers, if necessary.

Performing the Cut

When your material is loaded into the Silhouette and the proper cut settings are selected, you’re ready to send your project to the Silhouette. Simply press the Send button to begin.

Upon completion, you may unload your cutting mat and/or material by pressing the Unload button.

10 - Print & Cut

Silhouette electronic cutting tools have the special ability to read printed jobs sent from Silhouette Studio® in order to cut the contour lines defined in your workspace as they outline print information. In other words, you are able to print an image with filled color or effects to your regular home printer and then feed the printed sheet into the Silhouette to cut out around the printed image.

10.1 Registration Marks

The original Silhouette, Silhouette SD, Cameo, Portrait, and Curio models have an optic scanner for reading marks that can be printed by Silhouette Studio®. These marks are called registration marks. These marks will print around the border of your workspace and will be read by the Silhouette's optic scanner prior to cutting so that the Silhouette can triangulate according to where these marks are located and know exactly where the cut lines are defined around your printed images. Registration marks are only used when printing images for the purpose of performing Print & Cut jobs.



To access these marks, click on the Registration Marks icon in the Page panel.

You may enable the registration marks by selecting Type 1 or Type 2 under the Registration Mark icon. If desired according to the job being performed, these marks can be adjusted. Please note that while you may make the marks smaller, if the Silhouette fails to locate these marks, you may need to adjust the registration mark size to ensure the optic scanner is able to successfully locate these marks.

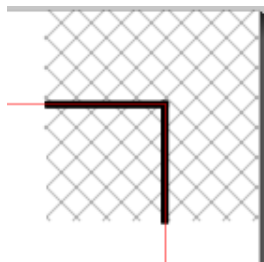

You will note that the marks have a hash mark fill around them.

This hash mark fill indicates that print information cannot be contained in this area in order for the optic scanner to operate properly.

10.2 Cutting Printed Images

With the registration marks displayed, you are ready to perform Print & Cut jobs. Again, this does not mean that the Silhouette will scan and cut around any print information. Rather the Silhouette is using the registration marks to know where your cut lines are defined around your printed image. Your image must have lines around your printed image which are defined to be cut (see the Line Styles section).

The following is an example of a Print & Cut job.

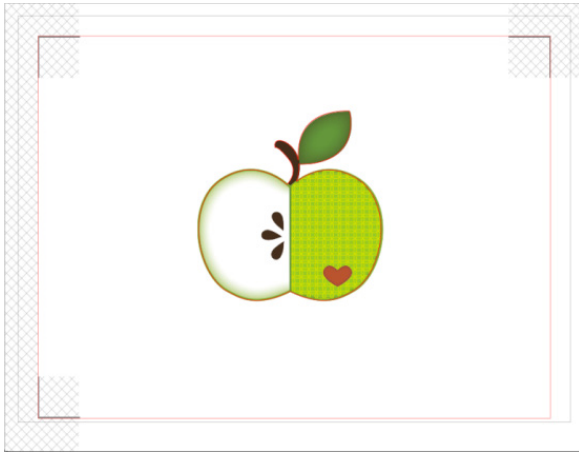

In this case, your printer will see the following to print out:



While the Silhouette will see the following to cut:

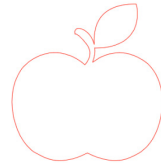



When your job is ready, you may print it by accessing the Print option.

Once printed, it is important to remember not to make any further adjustments to the document as it appears on your screen. If any objects are moved and the location of printed or cut information is altered, you will need to re-print your document.

To use the Silhouette's Automatic Registration Mark Reading feature, set up your job as directed in the previous section. If you have registration marks on your page in the design screen, your machine will know to detect them when you send your job to cut. The Silhouette's optic scanner will then locate the marks for you. Once all marks are successfully detected, the Silhouette will cut the defined lines around your printed image.

As previously noted, Silhouette Studio® allows you to fill any image with fill colors, gradients, and patterns. Though Silhouette does offer premade special Print & Cut images that are designed to only have print information inside and a cut edge around the outside of the image, literally any image can be turned into a Print & Cut image by using the tools provided in Silhouette Studio®.

11 - PixScan™



The PixScan™ feature requires the use of a PixScan™ mat (PixScan™ mat sold separately).

This feature allows for the use of images that are already printed which have not originated from the Silhouette Studio® software. The PixScan™ mat provides the ability to cut according to an image's actual size whether it be to provide a contour cut around the image, or to nest images into an oddly shaped material precisely, or to replicate a pattern at its original size.

11.1 Import from Scanner

When importing directly from a scanner, you may perform the following steps:

1. Place the intended printed image onto the PixScan™ mat which you wish to cut.

IMPORTANT: Ensure the image is within the mat's cutting area as shown by the black line border on the mat.

2. Click on the PixScan™ Icon in the Silhouette Studio® software.
3. Select the Import from Scanner section.
4. Place the image on the PixScan™ mat face down onto the scanner.
5. Select your scanner from the Source drop-down list and click on the Import PixScan™ Image from Scanner option.

Import PixScan Image from Scanner

IMPORTANT: If the PixScan™ mat is larger than the scanner, you may scan in two passes. You will need to ensure that all markings on the mat are captured along with the actual image. If scanning in multiple passes, you do not need to worry if the scanned images overlap. The software will knit the images together properly.

11.2 Import from Camera

When importing an image from a camera or camera phone, you may perform the following steps:

1. Place the intended printed image onto the PixScan™ mat which you wish to cut.
2. Take a picture of the image on the mat with your camera.

NOTE: For optimal results when photographing the PixScan™ mat, please ensure that:

- No zoom is used
- Lighting is even
- The entire mat is clearly visible in the image
- The PixScan mat is flat
- The cut media is contained within the black cut border

3. Transfer the image to your computer.
4. Click on the PixScan™ Icon in the Silhouette Studio software.
5. Select the Import from File section.



Import PixScan Image from File

6. A window will pop up for you to navigate to and select your image.
7. Click on Open once your image is selected.

NOTE: If a calibration profile does not already exist for your model of camera, you will need to calibrate the PixScan™ feature. PixScan™ calibration is only necessary to perform once per camera.

Calibrating your Camera

The following steps may be performed to create a PixScan™ Camera Calibration profile:

1. Click on the PixScan™ Icon
2. Select the Camera Calibration section

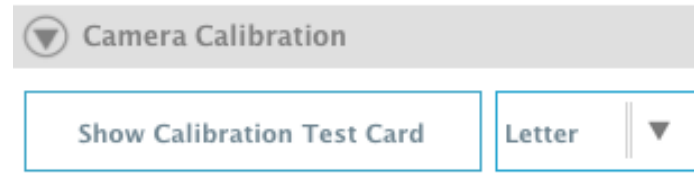

3. Click on the Show Calibration Test Card option
4. Go to File > Print and print out the page

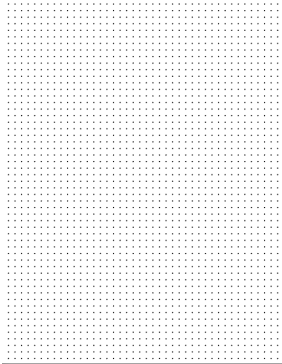

NOTE: It is okay if the entire page is not displayed or some of the dots are cut off

5. Take a picture of the printed calibration page from a bird's-eye view, ensuring that the calibration dots fill the entire image

NOTE: For optimal results when photographing the calibration image, please ensure that:

- No zoom is used
- Lighting is even
- The photo is clear and crisp
- The calibration image is resting on a flat surface
- The camera is parallel and in line with the calibration image
- Only the calibration dots are showing in the photo



6. Once you have your image saved on your computer, click on the plus (+) icon under the Camera Calibration section of the PixScan™ panel.
7. A window will pop up for you to navigate to and select your calibration image
8. Click on Open once your image is selected

Your PixScan™ calibration is now set up for the camera in use. Again, this process is only necessary any time a new camera is in use. You may select a PixScan™ Camera Calibration profile for any previously calibrated camera at any time depending on which camera is used to capture your image.

11.3 Using PixScan™ images

Once you have your PixScan™ image loaded, you are ready to create or place your cut lines.

Contour Cutting

Please see Tracing (Section 6.14) for further information on creating cut lines to associate around your image. You may find it preferable to add a small Internal Offset (e.g. 0.2mm) after tracing in order to avoid white borders on traced PixScan™ images.

Material Nesting

If using a uniquely shaped material that has been scanned or photographed on the PixScan™ mat, you may use the Tracing feature (Section 6.14) to find the contour of the material. You may then use the Nesting feature (Section 6.11) to Set Selected Shape as Boundary and nest any images into the material's border. This will allow for precise placement of images you are seeking to cut into the uniquely shaped material.

12 - Curio Features

Some features found in Silhouette Studio® can only be used when the Curio is connected. The Curio provides select options that cannot be performed by other Silhouette tools.



12.1 Embossing

The Silhouette Curio™ is capable of embossing when using the Curio's embossing mat. Once the embossing mat has been set up for use, you may go to the Embossing icon.

At the top of the Embossing menu, you will find an option to select either Deboss or Emboss. This option will apply to the entire document and is not object-specific.



When Deboss is selected, your job will be processed as it is viewed on screen. The action of the embossing tool pressing down onto your material will create a recessed relief of the image, or Deboss effect.



When Emboss is selected, while you will continue to see your job as it has been designed on screen, your job will be flipped horizontally when processed so that the entire page is mirrored. The action of the embossing tool pressing down in a mirror image will allow the material to be flipped over after the job is completed to display a raised image, or Emboss effect.

IMPORTANT: When selecting to Emboss, make sure you place your material onto the embossing mat face down.

Select one of the following embossing options in the software to set up your image to be debossed or embossed as desired.



Emboss/Deboss

Embossing/debossing is made possible when using the Silhouette Curio™ embossing mat with an embossing tool. If no special effects from this panel are applied, the Silhouette Curio™ will simply emboss/deboss the outline of your image. The effects and options found in the Emboss/Deboss section provide additional options that may be desirable when using an embossing tool.

An Effect can be selected to fill in any image with an embossing pattern. To apply an embossing Effect, select your image and then click on the desired Effect.

Spacing will control how compact or spread out the applied Effect will appear.

The Angle option will control the applied angle of the selected Effect.

The Spacing and Angle options are dynamic and will automatically adjust when images are resized or adjusted. However, if you wish to set these options to be static after they are created to your liking, you may click on the Release Emboss option.



Score & Emboss

The Score & Emboss option is a special action that will first score around the edges of your image (with a blade), and then will press inside of the score line (with an embossing tool). The resulting effect provides a more dramatic deboss relief or raised emboss effect.

IMPORTANT: This feature is intended for use with Silhouette brand “Score & Emboss Paper”. Silhouette cannot guarantee effective results when using other material types. All further instructions assume the use of Silhouette brand “Score & Emboss Paper”.

When going to Score & Emboss an image, begin by selecting the Embossing Tip type.



Selecting the Fine embossing tool will provide a more pronounced emboss/deboss effect and have the emboss line closer to the score line. Selecting the Wide embossing tool will provide a softer emboss/deboss effect and have the emboss line farther from the score line.

IMPORTANT: Make sure the Embossing Tip selected in the software matches the actual Embossing Tool that has been placed into the Silhouette Curio™

You may adjust additional settings found under the Score & Emboss options if desired. The options found here will allow you to control how many embossing passes are performed after the image has been scored.

By default, the image will only be embossed a single time close to the score line.

Raising the Passes option will allow you to perform an additional number of impressions made inside of the score line.

Fill will have the selected image filled entirely by a series of emboss lines.

Once you have all settings to your liking, you may then select the image and click on Apply Score & Emboss Lines.

When ready, you may go to adjust your settings if needed by clicking on the Adjust Cut Settings button. The action to Apply Score & Emboss Lines will have automatically set up your job to be scored and then embossed according to the options selected.

IMPORTANT: Ensure that your blade is placed into the Curio’s left-hand tool holder (identified by the red circle) at a blade setting of “1”, and that your desired embossing tool is placed into the right-hand tool holder (identified by the blue circle).

Print & Emboss



The Print & Emboss option is very similar to the Print & Cut option, which uses registration marks to provide proper alignment around a print image. Print & Emboss jobs allow you to print an image onto a material's surface and then press down onto the opposite side of the printed surface with an embossing tool. The resulting effect produces a printed image that is embossed. The emboss effect can either be around the edge or filled in according to the Emboss/Deboss options previously selected.

Begin by placing your print design on screen and create the desired embossing lines around or within the printed image.

TIP: If using a Print & Cut image that already has a cut line created around the image and which also has surrounding white space, you can select the image and go to the Modify options to select Intersect. This will have all white space outside of the cut line contour trimmed. If you desire to assign an emboss fill type, you may then right-click Copy, and then right-click Paste In Front. The design can then be selected to apply any emboss fill type for use with the Print & Emboss feature.

You may then go to the Print & Emboss section in the Emboss tool panel and click on the "Print" button under Step 1. This will have your image sent to your printer with printed registration marks.

IMPORTANT: Please allow ample time for ink to dry prior to placing it onto the embossing mat. Ink that has not fully dried may transfer an imprint of the image onto the embossing mat surface. While this will not degrade or harm the mat, it may be undesirable.

Remove the printed page with the cut-out registration marks from your Curio cutting mat. Flip the printed page over to the back (non-printed side) and place it face down onto your embossing mat. You may then slide the three small black squares received with your Curio under the cut-out registration marks so that the marks appear to be black.



IMPORTANT: It is recommended to allow ample time for ink to dry prior to placing it face down onto the embossing mat. Some ink may transfer onto the embossing mat. Such is normal and will not negatively affect further usage of the embossing mat.

Replace the blade with an embossing tool into the Curio's left-hand tool holder (identified by the red circle) and click on the "Emboss" button under Step 3. The back of the page will be indented along the emboss lines so that a raised emboss effect will be visible when the page is viewed from the front.



12.2 Stippling

Stippling is the process of marking a material's surface with numerous small dots to make a pattern. The Silhouette Curio™ provides the ability to create stipple points by either converting lines into stipple points, or by converting imported print images into stipple patterns.

The Stipple option assumes you are either using a Stipple Tool (item sold separately) or a felt tip pen.

Stipple

The Stipple section will allow you to convert lines into stipple patterns or to fill images with various stipple patterns.

To convert lines to stipple points, check the box for Stipple Edge under the Stipple menu. After doing so, you may control the stipple point distance by adjusting the Spacing option.

Selecting one of the Stipple Fill types (Patterns or Shapes) will have the selected line image filled with your desired pattern or shape. Only one Pattern or Shape option can be selected at a time. The following settings can be adjusted according to your Pattern or Shape selected:

Grid Spacing: Zooms the selected stipple Shape in or out

Stipple Spacing: Controls stipple point spacing to either be closer together or spaced farther apart

Angle: Controls the angle of the stipple fill

Offset: Controls how close to or far from the edge of the filled shape the Stipple Fill will appear

The Stipple Size option will adjust the display size of the stipple points on your screen. This does not control the actual resulting size of the created stipple point. This is for display purposes only.

When the Print Stipple option is checked, your image can be sent to a printer in order to print out an image of the selected stipple settings.



Stipple Trace

The Stipple Trace section will allow you to convert imported raster images (such as JPG, PNG, and other supported bitmaps) into stipple patterns.

Once you have opened an external image you own (as discussed in Section 3.4) you may click on the Select Stipple Area button. This will allow you to draw a box around the intended area of your imported image in order to create a stipple pattern. This selected area once drawn may be adjusted or moved like any other object in the software as you may need to expand or refine the Stipple Trace area. The Stipple Trace area selection will provide a preview of the original image with a black-dotted image showing how the intended stipple points will be created.

After selecting all desired Stipple Options (as noted below) and your stipple pattern appears as you would like, you may click on the Create Stipple button to have the pattern created.

Stipple Style: Various stipple styles and settings can be adjusted to provide altering stipple effects.

Invert: The invert checkbox will have the contra-positive image traced.

Density: Generally, lighter regions of the drawing will be populated with fewer stipple points and darker regions are more densely populated. The darkness of any region is magnified by the Density setting which affects the population, or density of stipples rendered in that region.

Refinement: Stipples are rendered at the points of a small invisible square grid, the spacing of which is defined by “Grid Spacing”. Some Stipple Style options allow this to be adjusted so that the stipple points appear at half, third, or quarter grid squares, thus higher values provide a more randomized display of stipple points which may have a more natural or less blocky appearance.

Grid Spacing: Specifies the distance between rows and columns of the square grid upon which the stipple points are positioned. Lower values provide a finer grid upon which the stipple points may be positioned.

Selecting the Stipple Tool

When opting to stipple, you may either use a felt-tip type pen or a Silhouette Stippling & Embossing Tool. Whenever performing a stippling job, you will want to select the Stipple Tool for your material type under the Cut Settings panel.

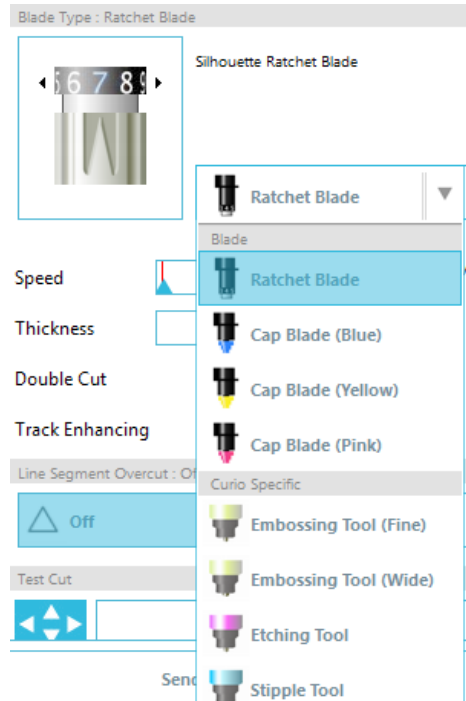

To select the Stipple Tool, select your material type in the Cut Settings panel and then click on the tool type drop-down option.

You can then scroll down to select the Stipple Tool. Once selected you will have two new tool setting options available.

While the action of Stippling is generally an up\down action, the Stipple Size option here will allow you to create a larger stipple point by dropping the tool and having the stipple point created in a circular motion, thus making the stipple point larger. The default setting of 0.00 mm will simply have the stipple point created at the tool's actual point diameter.

When using the Stipple Tool to stipple metal surface, such as the Silhouette brand Metal Stippling Sheets, you may check the Increased Stipple Force box in order to create a harder punched stipple point.

12.3 Multiple tool use

The Silhouette Curio™ and Silhouette CAMEO® 3 have two tool holders so that multiple tools can be used simultaneously. This means that you are able to perform two different actions during the same job, such as cut, emboss, etch, stipple, and sketch.

When Silhouette Curio™ is detected, Silhouette Studio® will provide an option in the Send panel to allow various line sets to be assigned to the different tool holders.

When in the Send Panel, you may select your desired object in your workspace and then click on the associated Tool holder option you want to use.



This will assign the selected line to be performed by the desired tool you have placed into the associated tool holder.

When in the Advanced Cut Mode, you can assign your lines to be performed by the desired tool holder by clicking onto the associated circle found under the Tool column. This can be performed according to Line Color or Fill Color, or if using the Designer Edition version you may also set up your job to various tools according to Layer.

The image shows a panel titled "Cut Order" with three tabs: "Layer", "Line Color", and "Fill Color". Below the tabs is a table with three columns: "Tool", "Color", and "Material".

Tool	Color	Material
<input checked="" type="radio"/> <input type="radio"/>	<input checked="" type="checkbox"/> <input type="checkbox"/> RGB (244,0,0)	Score
<input type="radio"/> <input checked="" type="radio"/>	<input checked="" type="checkbox"/> <input type="checkbox"/> RGB (10,108,)	Emboss (Fine)
Pause		
<input checked="" type="radio"/> <input type="radio"/>	<input checked="" type="checkbox"/> <input type="checkbox"/> RGB (63,198,)	Silhouette Sketch Pe

Clicking on the left-hand red circle will have the selected row performed by the Curio's left-hand tool, whereas clicking on the right-hand blue circle will have the selected row performed by the Curios' right-hand tool.

If you have more than two tool types you wish to use within the same job, you can right-click to add a pause in order to stop the Curio between actions and change out your tool as needed.

13 - Designer Edition Plus Features

Silhouette Studio® Designer Edition Plus has a two extra features: appliqué embroidery and advanced rhinestones.

13.1 Appliqué Embroidery

Silhouette Studio® Designer Edition Plus enables you to import appliqué embroidery files. If your embroidery file has a placement stitch layer, you can use it to cut out the appliqué shapes using your Silhouette cutting machine.

To do so, upload your embroidery file to Silhouette Studio®. You can import the following embroidery formats with Designer Edition Plus:

PES (Brother, Babylock, Deco, Singer)

DST (Tajima, Barudan, Toyota)

EXP (Stellar, Melco)

JEF (Janome)

XXX (Singer)

Open your file in the design screen. Delete the extra embroidery shapes so only the placement stitch line remains.



Send your shape to your Silhouette and cut your shape out of your fabric. Now you have a perfectly cut appliqué.

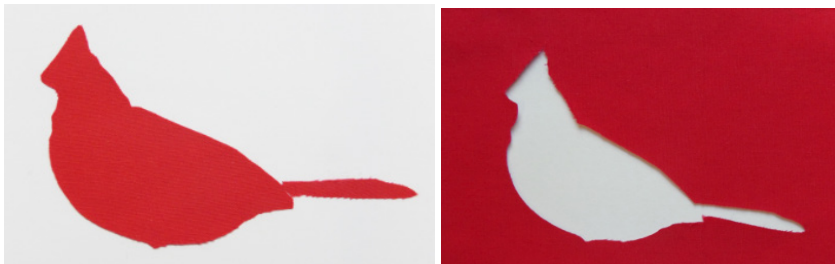

Sketching with Embroidery Files

You can convert embroidery designs to sketch artwork using Silhouette sketch pens.

Upload your file to Silhouette Studio®. Assign each layer a color. Send the image to your Silhouette with each colored layer corresponding to a colored sketch pen.





13.2 Advanced Rhinestones

The advanced rhinestone tools in Silhouette Studio® Designer Edition Plus provide additional customization options and enable you to view your designs with photo-realistic renderings.

Custom Rhinestones

You can draw your own custom rhinestone shapes in Silhouette Studio®, or you can import images of your custom rhinestones using a PixScan™ mat (see the PixScan™ section for more information).

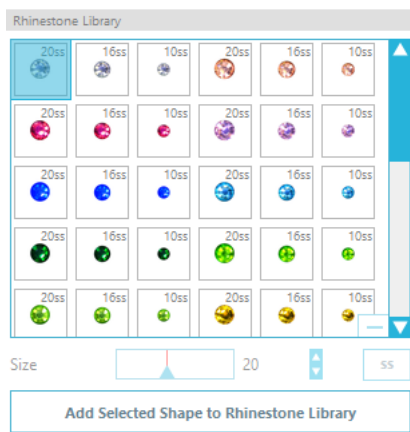

Once you have your shape drawn or have placed the image of your custom rhinestone on the page, select the image. Then, click the 'Add Selected Shape to Rhinestone Library' button. This will add your shape to a section called 'User Rhinestones' underneath the preloaded stock rhinestones. The rhinestone shape will remain in your library so you can use it for future projects.

Resize Rhinestones to Non-Standard Sizes

The size of circular rhinestones can be defined in 'ss' or in the dimensional units ('mm' or 'inches') set in your preferences settings. The width / height of non-circular rhinestones is defined in the dimensional units ('mm' or 'inches') set in your preferences settings. You can resize your custom rhinestones by clicking on the slider bars under your rhinestone library.

Placing Individual Rhinestones

To place individual rhinestones in your design, you can select the rhinestone you want and drag and drop it in place. Or you can select 'Single Click' from the advanced rhinestone menu. Otherwise, there are two options to place rhinestones in your design: single and multiple.

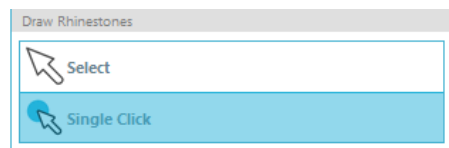

Single Click mode provides a rhinestone cursor in the draw area which places the currently selected rhinestone from the Rhinestone Library on the page, allowing you to quickly place a repeated rhinestone.

When you are in 'Multiple Rhinestones' mode, the Rhinestone Cursor rotates through the sequence of Rhinestones defined in your 'User Rhinestones' list, allowing sequences of different rhinestone types to be quickly placed.

Clicking the Rhinestone Cursor above a rhinestone which has already been placed in the draw area causes that rhinestone to be replaced by the new one, positioning the new rhinestone at the same center.

Placing Rhinestones as Outlines or Fills

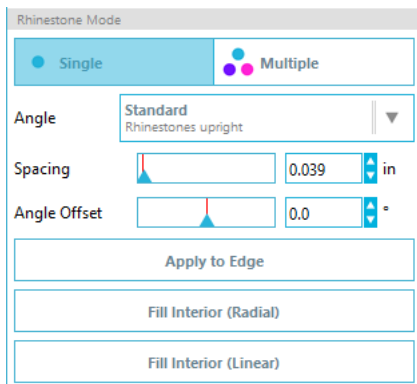

You can create outlines or fills using either a single rhinestone style or a multiple rhinestone pattern.

To use a single rhinestone style, you can select a single rhinestone and outline or fill your design with it. First, select your image. Next, under 'Rhinestone Mode' select 'Single'. Then, select which rhinestone you are using for your design.

There are three adjustment options: Angle, Spacing, and Angle Offset.

The following options are available in the drop down 'Angle' menu.

Standard: Rhinestones are oriented in a uniform direction.

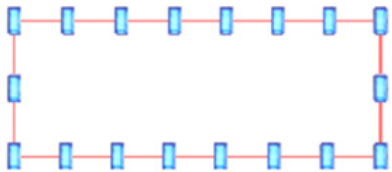

Center: Rhinestones are oriented to point toward the center of the boundary shape.

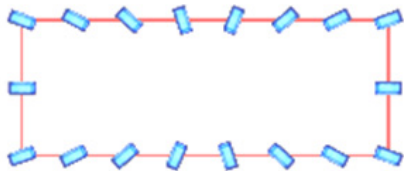

Perpendicular: Rhinestones are oriented perpendicular to the contour upon which they sit.

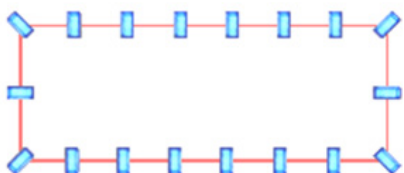

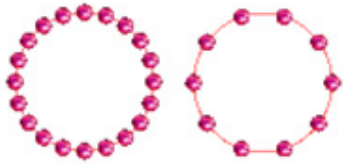

'Spacing' adjusts how much space there is between each individual rhinestone.



'Angle Offset' allows you to adjust the angle at which rhinestones are placed.

Hearts with no angle offset and hearts with 45° angle offset.

After you have selected your Angle, Spacing, and Angle Offset, click 'Apply to Edge'.

Fill Options

There are two options to fill your design.

'Fill Interior Radial' positions rhinestones on edge of the path and on concentric contours in the interior.

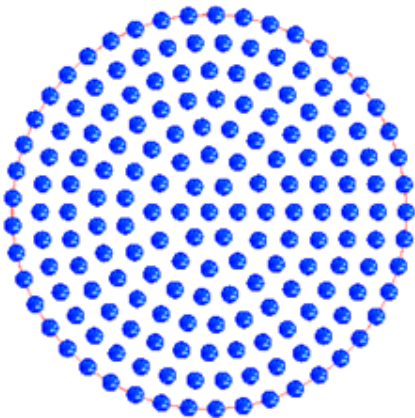

'Fill Interior Linear' positions rhinestones in a grid-like formation in the interior.

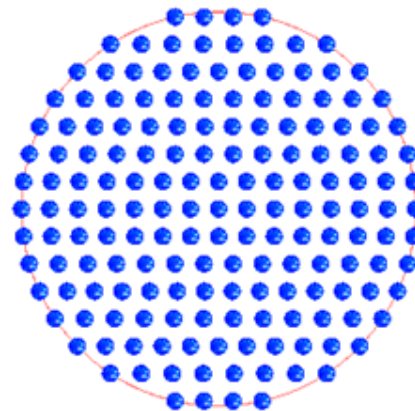

Multiple Rhinestones

Multiple Rhinestone Mode functions similarly to Single Rhinestone Mode except the outline or fill uses a multiple rhinestone pattern.

When in 'Multiple Rhinestones' mode, you can make a pattern of rhinestones for your design. To make a pattern, click on the rhinestone you want and drag it down to 'User Rhinestones'. Go back to your rhinestone library and click the next rhinestone you want and drag it down next to the first one. You can drag down as many rhinestones as you want to create your pattern. Each rhinestone will automatically be placed at the end of the pattern, but by clicking and dragging, you can rearrange them to create your desired look.

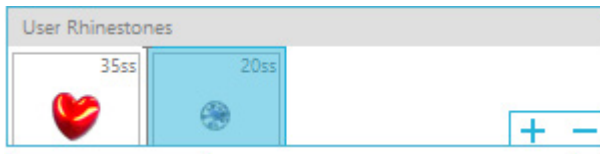

Total (All Shapes)

Totals (All Shapes)				
6ss	10ss	16ss	20ss	Other
0	12	0	14	9

At the bottom of the Advanced Rhinestone menu is a total rhinestone count. It tracks how many rhinestones of each size you use in your design.

14 - Business Edition Features

Silhouette Studio® Business Edition has a few helpful tools to aid in the production of large, intricate, or batched projects.

14.1 Multi-Cutter Support

The Silhouette Studio® Business Edition provides multi-cutter support. This means that when using the Business Edition, you are provided the ability to send cut jobs to multiple Silhouette cutting units at the same time as they are hooked up to your computer.

To utilize the ability to send jobs to multiple Silhouette units hooked up to the same computer, you may simply go to the Send panel and select which Silhouette unit you would like to send the job to and then press the Start button.

You can use this feature to cut the same job or different jobs for whichever document tab is selected and actively displayed as you opt to start the job.

The option to use multiple Silhouette units also provides the capability in the Business Edition to name your Silhouette units within the program. This is so you are able to determine which job is being sent to which unit. To rename a connected Silhouette, simply click on the Silhouette model name (shown in grey below) in the Send to Silhouette Screen:

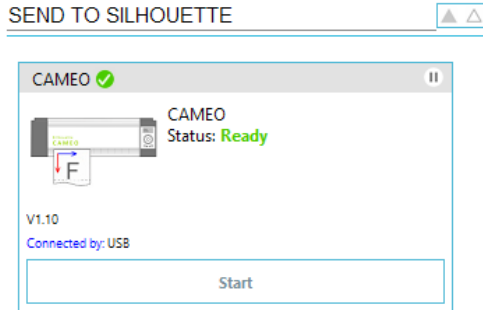

Once you click on the model name, you can type in any new desired name for the specific Silhouette unit. The name will be retained whenever using the computer that was used to create the name, even if the unit is unplugged and then later plugged back in. However, please note that the naming is specific to the computer in question.

14.2 Ai/EPS/CDR file compatibility

The Silhouette Studio® Business Edition provides the ability to open Ai, EPS, and CDR files directly which have been created from other major vector imaging software programs (such as Adobe Illustrator® or CorelDraw®).

To access this feature in the Business Edition, go to the File menu and select Open. If on a PC, you will need to select the file type you are seeking to open and select the Ai, EPS, or CDR option.

You may either select to cut by layer and simply enable the desired layers, or opt to cut by line color and either enable the “no color” line to be cut or re-color your lines as desired using the Line Color tool.

You may alternately opt to use the Silhouette Connect™ program to cut these files from their native software programs.



14.3 Design View vs. Media Layout View

Silhouette Studio® Business Edition provides a different view option to enable users to view both the original Design View of how images are laid out from a design aspect and a Media Layout View of how lines are processed to actually appear in the resulting cut job. While the traditional “what you see is what you get” Design View can be utilized and jobs processed in this manner when using the Business Edition, there is an additional option to change to the Media Layout View in order to maximize efficiency of laying out designs to be cut on specialty materials commonly used in business settings.

This side-by-side view capability provides access to further Business Edition features, such as Matrix Copy options, Media Layout Nesting, and Tiling.

Design View

Selecting this option will put the software into the traditional single pane view and have objects cut out as they have been placed in their original design.

Media Layout View

Selecting this option will provide a side-by-side view of your original layout (Design View on the left-hand side of the screen), and a view of the way your job will be processed to cut to your media, or material that is being cut (Media Layout View on the right-hand side of the screen).



14.4 Tiling Feature

The Silhouette Studio® Business Edition provides an automated Tiling feature.

The Tiling feature provides a method by which a larger job can be cut from a series of smaller tiles which are then assembled after the cutting process is completed in order to create the larger scale job.

By example, the Tiling feature will allow the user to design a large scale image of 24 inches height by 24 inches width and cut it out in several passes. Even though such a material size cannot be cut in a single pass due to the Silhouette's maximum cutting width limitation of 12 inches, the Tiling feature will automatically segment the job into a series of smaller jobs that can be cut out and then assembled to achieve the final 24 inch by 24 inch project.

The Tiling feature is available only when running the Business Edition version in the Media Layout mode.

While the original design can retain its original design layout, the Tiling option will provide a method to re-arrange the design to be cut in a series of multiple panels, thus allowing the target project which is larger than the media being used to be successfully created in a series of multiple smaller jobs.

The following options are available in the Tiling panel:

Tiling Active

This option turns the feature on or off as desired. The option can be combined with other Business Edition features, such as Media Layout Nesting and Matrix Copy. (NOTE: This the processed design shown in the Media Layout View will only change to multiple panels if the image exceeds the available cutting area.)

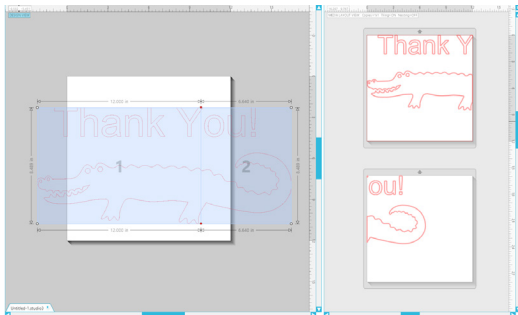

When Tiling is active, the Design View will display a series of numbered tiles to display how the project will be split up into the resulting cut jobs.

These tiles can be controlled by the following further available tools found in the Tiling panel:

Configure Position and Size - The options found in this section will allow for the adjustment of the tile sizes and positioning for how the tiles will process the resulting cut job.

Maintain Aspect - This option will maintain the aspect ratio of the master tile.

Automatic - This option will resize the tiles to the size of the project being cut. The tiling division lines will be positioned automatically according to the defined media size.

Custom - This option will allow you to edit the tiles by dragging the division lines and nodes.

Regular Grid - This option will resize the tiles to maintain width and height dimensions for the individual tiles, rather than sizing them according to the media size specifically.

Margin - This option will create an overlap of the resulting cut, which may be useful as overlap in the final resulting job may be required.

Show Dimensions - This option toggles the tile sizes on and off.

All Tiles - This option will have all tiles selected to be cut.

Selected Tiles Only - This option allows for selected tiles only to be cut. Alternately, you may click in the Design View on the tiles to toggle them on or off.

Separation- This option toggles the tile sizes on and off.

14.5 Automatic Nesting Preview



The Silhouette Studio® Business Edition provides an Automated Nesting preview mode where shapes are automatically nested within the Media Layout View to provide efficient usage of the material being cut, while maintaining the image's original positioning in the Design View thus allowing the user to continue editing and refining the design.

The Media Layout Nesting option is available only when running the Business Edition version in the Media Layout mode.

While the original design can retain its original design layout, the Media Layout Nesting option will provide a method to re-arrange the objects to be cut in a manner that makes the most effective use of your media.

The following options are available in the Media Layout Nesting panel:

Nesting Active - This option turns the feature on or off as desired. The option can be combined with other Business Edition features, such as Tiling and Matrix Copy.

Interlock Shapes - This option will nest concave shapes together in more efficient ways and attempt to interlock them to save more space on your media.

Maintain Grain - When enabled, the nesting feature is constrained to leave images unrotated, or to rotating only by 180 degrees. This may be useful when using specialty media that has a grain in order to ensure the grain runs in the desired direction for the resulting cut out images.

Align - When enabled and images are rotated to an irregular angle in the Design View, the Align option will make the image upright to compensate prior to determining the best angle to nest the shape into.

Whole Words - This option will keep letters from words together which have been created with the Text tool, instead of nesting each individual letter.

Maintain Groups - This option will keep any grouped images in their original grouping rather than nesting each individual object.

Rotations - The Rotations option will allow or restrict the level of angles you may allow the images to be rotated. For example, a Rotations setting of "0" will hold the images exactly in their original angle of rotation whereas a Rotations setting of "2" will allow rotations of 0° and 180° turns for the images. A Rotations setting of "4" will allow images to be rotated at angles of 0°, 90°, 180°, and 270°. As the Rotations setting is raised, the number of possible rotation angles for each image increases. The setting is present because while the highest setting may attempt to make the most effective use of space, there may be instances where the angle of images is important and it is more desirable to hold images in a certain angle.

Padding - This option controls the minimum distance between two adjacent shapes after they have been nested.



14.6 Matrix Copy Feature

The Silhouette Studio® Business Edition provides a Matrix Copy feature. This feature will provide the ability to create matrix of multiple copies of the same project that are replicated during the processing of the cut job but which do not actually alter or effect your original design.

The Copy feature is available only when running the Business Edition version in the Media Layout mode.

While the original design can retain its original design layout, the Copy panel options will provide a method to replicate the design to cut multiple copies as desired.

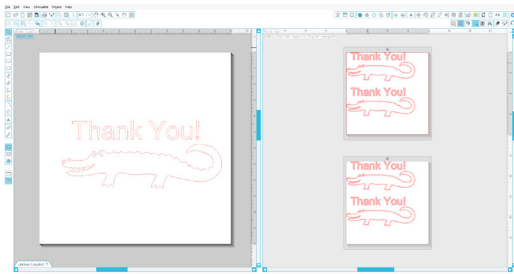

The following options are available in the Copy panel:

Rows - This option will provide multiple rows of the job as defined.

Columns - This option will provide multiple columns of the job as defined.

Limit to Media - Pressing this button will take the specified numbers for the rows and columns entered and remove any which exceed the allowed size of your media size.

Separation - The Horizontal option determines the horizontal spacing between copies while the Vertical option determines the vertical spacing between copies.

14.7 Automated Weed Line Feature



The Silhouette Studio® Business Edition provides a Weed Settings tool. This feature provides the option to create weed lines within open line paths for easier weeding of materials such as vinyl and heat transfer. Options include a surrounding weed line border as well as internal weed lines inside the design's open spaces (such as within letters) to provide an easy method of removing excess material after the completion of the cut job.

The Weed Settings panel can be found when running the Business Edition in the upper right-hand side of the screen.

The following options are available in the Weed Settings panel:

Show Weed Border - This option enables an automated weed border to be created around the entire cut job.

Padding - The option will adjust the padding dimension to add or remove spacing between the border and the included weed border.

Weed Lines - The Weed Lines option provides an option to include internal weed lines, as they may be possible to include for the image.

All weed borders and internal weed lines are automated and adjusted on the fly as adjustments are made to the placement or sizing of objects placed on your workspace.

All weed borders and lines are displayed in blue:

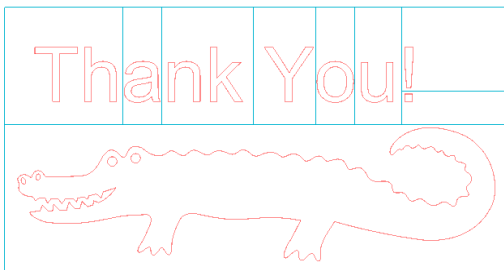

15 - Troubleshooting

If you experience problems, a list of common trouble-shooting tips and further support information may be found below.

15.1 Common Troubleshooting Tips

Blade won't cut through material

If using the original Silhouette, make sure the notch on the blade (the black “fin” on the base of your blade) is turned to the right, facing the blue power light in the 3 o'clock position. When the notch is faced in this direction and locked into place, the blade will be lowered slightly and thus deliver more cutting force. Again, this would be for the original Silhouette only.

Regardless of which Silhouette model you have, blade positioning could still be an issue if the blade had been removed recently to change the cap or make an adjustment to the blade level (depending on the blade type being used). The blade may not be fully seated in the holder and thus not delivering clean results when cutting. To check this, unlock the blade and while holding the lock lever in place, twist and push the blade down to make sure it is seated all the way down in the holder.

You may also check the cut settings. If you are cutting with a depth that is too shallow, you may need to adjust your cutting settings or blade cap/setting according to the type of paper or media you are trying to cut. Use the Test Cut button to ensure your settings are set up correctly for the media type you are using prior to going through the entire cutting process. If the test cut does not work, you most likely need to re-adjust the settings. If the test cut works, the actual cut job should work.

If you find for any reason that there are areas not giving a clean cut, you may also wish to select to use the Double Pass option in the Send Panel to ensure any problem areas are given an extra pass during the cut job.

Images are not aligned when cut

When cutting regular paper or cardstock that does not have its own adhesive-backing, please ensure you have loaded your paper onto your cutting mat. This issue may be experienced if you are not using the cutting mat properly or are not using it with materials that would require the use of a cutting mat.

If you are using the cutting mat, you will want to ensure the mat's liner has been removed to expose the sticky surface so that your material is being held down in place firmly during the cutting process. If the mat has lost its adhesive quality for any reason and is not holding the paper firmly in place, this may cause your paper to drift as it is being cut.

If you are using the cutting mat and your paper is being loaded onto the cutting mat correctly and held firmly in place, you may be experiencing this issue if you have loaded your cutting mat or material into the Silhouette lined up with the far left-hand side of the machine, as opposed to lining up the cutting mat or material with the raised guide. If the cutting mat or material being cut is not lined up correctly with this guide and is not being initially grabbed between the two white rollers, you would experience the issue of your cutting mat or material drifting as it is being cut and your image would not be aligned properly.

New Hardware Wizard appears each time Silhouette is powered on

If your computer is asking you to install the software (even though it is already installed), this is likely when you are turning on the Silhouette or if you have unplugged the USB and are plugging it back in. Your computer is simply thinking there is a new hardware device it has not yet recognized. You may safely navigate through the automatic recommended installation as it simply is referring to the driver. The driver is contained on your installation CD, or in the case of downloading the software may be obtained from www.silhouetteamerica.com in the Support section. The driver is actually not necessary for proper use of the software, but may be used to quiet the Windows Plug & Play feature which tries to find hardware drivers when new devices are connected. After re-installing the driver, you should no longer receive this prompt to install.

NOTE: You may see a threatening message from Microsoft during driver installation that mentions the driver is a potential risk or has not passed Windows logo testing. Please note that the driver has been tested extensively and will safely work with Windows XP, Windows Vista, and Windows 7. Click on the “Continue Anyway” button and proceed with the driver installation process.

Unload Media is displayed immediately after loading (SD and Cameo models only)

This is not an error. Once you have selected one of the loading options, whether or not you have actually loaded anything into the machine, the Silhouette will think that material has been loaded and await further action to cut either through your computer or through a SD card. As it is waiting to cut, the initial option displayed will show Unload Media. This is displayed in case you had loaded your material incorrectly or if it was not loaded into the machine straight. After the cutting process has ended, you will likewise be shown this option displayed to unload your material.

If there is no material actually loaded yet and the Enter key was accidentally pressed, you may simply press the Unload Media button and then scroll over to again find the loading options on the Silhouette SD’s LCD screen to properly load your material to cut.

Cutting mat stuck in Silhouette (SD model only)

Turn on the Silhouette SD and press the arrow keys on the LCD screen of your Silhouette until the Unload Media option is displayed. Once displayed, press the Enter key. If the mat is not fully ejected, please perform these actions again until the mat is fully ejected. You may alternately power off the Silhouette SD and manually pull the mat from the machine.

Silhouette is loud during operation

Please lift the Silhouette's lid to ensure any tape that is connecting the motor to the side of the unit has been removed. If this was not previously removed, this would be the cause of the noises experienced when your machine was powered on. If the tape had been left on, no damage should have been experienced, but the noises heard would be atypical. Please remove the tape and again power the Silhouette unit back on.

Otherwise, please note that the Silhouette is unfortunately not a whisper quiet unit. The sounds you are hearing are likely normal.

ERROR: Could not connect to the Silhouette

If this message is displayed while Send panel, you will need to check your USB connection to ensure it is firmly connected from the computer into the Silhouette. You may wish to power off the Silhouette and then unplug both ends of the USB cord. You may then power the Silhouette back on and plug the USB cord back in to your computer and the Silhouette. If problems persist, close Silhouette Studio® and restart your computer.

ERROR: Detection of registration marks failed

When using registration marks for Print & Cut jobs, if this message is displayed, remove your media or cutting mat from the Silhouette and re-load. Most commonly, this error is encountered if the media or cutting mat was loaded so that it was not aligned properly with the loading guide marks, or the incorrect loading method was selected ("Load Media" versus "Load w/Carrier").

Download progress stops or download time continues to increase

If during the download process the progress stops and/or the estimated time continues to increase while the progress of how many remaining images to download stays the same, you may go to the Preferences screen and select Advanced. In this screen raise the HTTP Sockets setting until the remaining number of downloads begins to decrease showing further progress.

15.2 Calibration

Calibration of the tool is only required for adjustment of the cutting alignment as it relates to Print & Cut jobs and the alignment of cuts as they relate to printed information. This should only be performed if you specifically experience concerns with your cut lines not aligning with the contour of printed images during Print & Cut jobs that use registration marks. These options may be found by right-clicking anywhere in the Send tab and selecting Calibration.

For this operation, it is recommended to use a sketch pen in order to more clearly view the results and make adjustments accordingly.

To start, you will first need to select to Print the Calibration Test Page in order to print the test page to your home printer. Do not make any adjustments to the Calibration Test Page on your computer screen. Once printed, you will need to place the printed sheet onto your cutting mat as displayed on the screen. You will need to select the Load w/ Carrier option on the unit when using the Silhouette SD model or Load Cutting Mat option when using the Cameo or Portrait model.



Once loaded, use the arrow buttons on the screen to align your blade so it is pointing to the first cross mark in the area that is represented in green on your computer screen, or in other words, the upper left corner of the first mark.

Once the blade is in position, click on the Calibrate option. This will engage the Silhouette to attempt to read the mark and sketch/cut along the cross lines accordingly.

If either line is off, you will want to make adjustments according to the measurement of exactly how far above or below/how far to the left or right the resulting sketch or cut line was performed. To do this, measure the distance between the original printed mark and the actual performed mark.

If the performed horizontal mark is above or below the printed mark, you will need to adjust the vertical slider bar on screen according to the precise measurement observed between the printed and actual marks.

If the performed vertical mark is above or below the printed mark, you will need to adjust the horizontal slider bar on screen according to the precise measurement observed between the printed and actual marks.

You may then repeat this action as needed by again using the arrow buttons on screen to align with the green area as noted on screen with the next cross mark, click the Calibrate button, then observe results and continue to make corrections as needed until the actual marks performed align with the printed marks.

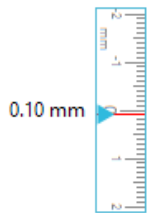

A Distance Adjustment tool can be found by right-clicking anywhere in the Send panel and selecting Distance Adjustment. This should only be used if noted that the measurement of your image noted on screen differs from the actual exact measured size. Necessary adjustments should be exceptionally rare.

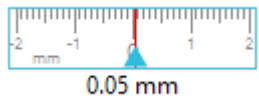

To use this tool, select to Print the Calibration Test Page to your home printer and place the printed sheet onto your cutting mat as displayed on the screen. You will need to select the Load w/ Carrier option on the unit when using the Silhouette SD model or Load Cutting Mat option when using the Cameo model. Once loaded, click on the option to Cut the Distance Adjustment Test Lines.

There will be two lines cut at positions 1 and 2 as labeled on your page. You will then need to measure the exact distance between the two lines and adjust the horizontal slider bar for under the Distance Adjustment section to match the exact measurement made. Once the measurement has been adjusted, the distance correction will be in effect. You may close the Calibration screen and continue to cut as desired. Additional test results are not necessary as further resulting test cuts will yield the same results on the test page and fall in line with the new adjusted number. You should only perform this test once.

15.3 Further Support Contact Information

Further support information may be obtained through the following sources:

Web: www.silhouetteamerica.com

Email: support@silhouetteamerica.com

Phone: 800.859.8243 (Toll-free U.S. & Canada only)

Silhouette America, Inc. is based out of Lehi, Utah and is open M-F
8 a.m. to 5 p.m. (Mountain time).

The specifications, etc., in this manual are
subject to change without notice.

May 2017, 11th edition
Silhouette America, Inc.

Silhouette Studio® Shortcuts

Document	PC	MAC
New Document	ctrl + n	cmd + n
Open Document	ctrl + o	cmd + o
Save Document	ctrl + s	cmd + s
Print	ctrl + p	cmd + p
Copy	ctrl + c	cmd + c
Paste	ctrl + v	cmd + v
Cut	ctrl + x	cmd + x
Undo	ctrl + z	cmd + z
Redo	ctrl + shift + z	cmd + shift + z
Pan Tool	spacebar	spacebar
Drag-zoom Tool	z	z
Fit to window	ctrl + 1	cmd + 1

File	PC	MAC
Save as	ctrl + shift + s	cmd + shift + s
Save to Library	ctrl + alt + r	ctrl + cmd + r
Close Document	ctrl + w	cmd + w
Quit	ctrl + q	cmd + q

Edit	PC	MAC
Paste in Front	ctrl + f	cmd + f
Duplicate	ctrl + d	cmd + d
Select All	ctrl + a	cmd + a
Deselect All	ctrl + shift + a	cmd + shift + a
Spelling	F7	fn + F7
Preferences	ctrl + k	cmd + k

Tools	PC	MAC
Select	v	v
Edit Points	a	a
Line	\	\
Rectangle	r	r
Rounded Rectangle	shift + r	shift + r
Ellipse	e	e
Polygon	p	p
Curve	c	c
Freehand	f	f
Smooth Freehand	shift + f	shift + f
Arc	shift + a	shift + a
Regular Polygon	shift + p	shift + p
Text	t	t
Eraser	shift + e	shift + e
Knife	k	k
Eyedropper	i	i
Eyedropper	ctrl + click	cmd + click

Object	PC	MAC
Group	ctrl + g	cmd + g
Ungroup	ctrl + shift + g	cmd + shift + g
Make Compound Path	ctrl + e	cmd + e
Release Compound Path	ctrl + shift + e	cmd + shift + e

Modify	PC	MAC
Weld	ctrl + shift + w	cmd + shift + w

Arrange	PC	MAC
Bring to Front	ctrl + shift +]	cmd + shift +]
Send to Back	ctrl + shift + [cmd + shift + [
Bring Forward	ctrl +]	cmd +]
Send Backward	ctrl + [cmd + [

Replicate	PC	MAC
Duplicate Left	ctrl + ←	cmd + ←
Duplicate Right	ctrl + →	cmd + →
Duplicate Above	ctrl + ↑	cmd + ↑
Duplicate Below	ctrl + ↓	cmd + ↓
Mirror Left	alt + shift + ←	alt + shift + ←
Mirror Right	alt + shift + →	alt + shift + →
Mirror Above	alt + shift + ↑	alt + shift + ↑
Mirror Below	alt + shift + ↓	alt + shift + ↓
Rotate 1 Copy	ctrl + shift + F1	cmd + shift + fn + F1
Rotate 2 Copies	ctrl + shift + F2	cmd + shift + fn + F2
Rotate 3 Copies	ctrl + shift + F3	cmd + shift + fn + F3
Rotate 5 Copies	ctrl + shift + F5	cmd + shift + fn + F5
Row of 3	ctrl + shift + →	cmd + shift + →
Row of 4	ctrl + alt + →	cmd + alt + →
Column of 3	ctrl + shift + ↓	cmd + shift + ↓
Column of 4	ctrl + alt + ↓	cmd + alt + ↓
Fill Page	ctrl + shift + f	cmd + shift + f

View	PC	MAC
Show Design Page	ctrl + shift + d	cmd + shift + d
Show Store	ctrl + alt + s	cmd + alt + s
Show Library	ctrl + alt + l	cmd + alt + l
Show Send Page	ctrl + F2	cmd + fn + F2
Show Grid	g	g
Grid Panel	ctrl + F4	cmd + fn + F4
Page Panel	ctrl + F1	cmd + fn + F1
Print Border	ctrl + shift + p	cmd + shift + p
Cut Border	ctrl + shift + l	cmd + shift + l
Center of Rotation	o	o
Registration Marks Window	ctrl + F3	cmd + fn + F3
Media Layout View	ctrl + shift + v	cmd + shift + v

Other	PC	MAC
Registration Marks	m	m
Cut Style = Cut	ctrl + t	cmd + t
Cut Style = No Cut	ctrl + shift + t	cmd + shift + t
Ruler	ctrl + r	cmd + r
Crosshairs	ctrl + h	cmd + h
Edit Object	Double Click	Double Click
Scroll Left/Right	ctrl + scroll wheel	cmd + scroll wheel
Zoom In/Out	alt + scroll wheel	alt + scroll wheel